



 **FLEXmax™ 60**

 **FLEXmax™ 80**

Maximum Power Point Tracking Charge Controller

User's Manual

Installation and Programming

Warranty Summary

Dear OutBack Customer,

Thank you for your purchase of OutBack products. We make every effort to assure our power conversion products will give you long and reliable service for your renewable energy system.

As with any manufactured device, repairs might be needed due to damage, inappropriate use, or unintentional defect. Please note the following guidelines regarding warranty service of OutBack products:

- Any and all warranty repairs must conform to the terms of the warranty.
- All OutBack equipment must be installed according to their accompanying instructions and manuals with specified over-current protection in order to maintain their warranties.
- The customer must return the component(s) to OutBack, securely packaged, properly addressed, and shipping paid. We recommend insuring your package when shipping. Packages that are not securely packaged can sustain additional damage not covered by the warranty or can void warranty repairs.
- There is no allowance or reimbursement for an installer's or user's labor or travel time required to disconnect, service, or reinstall the damaged component(s).
- OutBack will ship the repaired or replacement component(s) prepaid to addresses in the continental United States, where applicable. Shipments outside the U.S. will be sent freight collect.
- In the event of a product malfunction, OutBack cannot bear any responsibility for consequential losses, expenses, or damage to other components.
- Please read the full warranty at the end of this manual for more information.



The OutBack Power Systems FLEXmax 80 and FLEXmax 60 Maximum Power Point Tracking Charge Controllers are ETL listed in North America to UL1741 (Inverters, Converters, Controllers, and Interconnection System Equipment for Use with Distributed Energy Resources). It is also in compliance with European Union standards EN 61000-6-1 and EN 61000-6-3 (see page 91).

About OutBack Power Systems

OutBack Power Systems is a leader in advanced energy conversion technology. Our products include true sine wave inverter/chargers, a maximum power point charge controller, system communication components, as well as breaker panels, breakers, accessories, and assembled systems.

Notice of Copyright

FLEXmax 60 and FLEXmax 80 Maximum Power Point Tracking Charge Controllers User's Guide: Installation, Programming and User's Manual
Copyright © 2008 All rights reserved.

Disclaimer

UNLESS SPECIFICALLY AGREED TO IN WRITING, OUTBACK POWER SYSTEMS:

- (a) MAKES NO WARRANTY AS TO THE ACCURACY, SUFFICIENCY OR SUITABILITY OF ANY TECHNICAL OR OTHER INFORMATION PROVIDED IN ITS MANUALS OR OTHER DOCUMENTATION.
- (b) ASSUMES NO RESPONSIBILITY OR LIABILITY FOR LOSS OR DAMAGE, WHETHER DIRECT, INDIRECT, CONSEQUENTIAL OR INCIDENTAL, WHICH MIGHT ARISE OUT OF THE USE OF SUCH INFORMATION. THE USE OF ANY SUCH INFORMATION WILL BE ENTIRELY AT THE USER'S RISK.

Date and Revision

April 2008 REV A

Contact Information

OutBack Power Systems
19009 62nd Ave. NE
Arlington, WA 98223
Phone (360) 435-6030
Fax (360) 435-6019
www.outbackpower.com

TABLE OF CONTENTS

SCOPE.....	5
INTRODUCTION.....	5
INSTALLATION GUIDELINES AND SAFETY INSTRUCTIONS.....	6
Standards and Requirements.....	6
Battery Safety.....	7
INSTALLING THE Charge Controller ON FLEXware ENCLOSURES.....	10
OPEN CIRCUIT VOLTAGE/WIRE AND DISCONNECT SIZING.....	10
CHARGE CONTROLLER CONNECTIONS.....	12
HOW TO READ THE Charge Controller SCREEN DIAGRAMS.....	16
POWERING UP.....	17
STATUS SCREEN.....	20
END OF DAY SUMMARY SCREEN.....	21
RECHARGING USING THE PV ARRAY.....	21
ACCESSING THE MAIN MENU.....	22
CHARGER SETUP.....	23
AUX MODE AND ITS FUNCTIONS.....	24
AUX Mode Path.....	25
AUX Modes Described.....	26
Programming the AUX Modes.....	27
Vent Fan.....	27
PV Trigger.....	28
Error Output.....	31
Night Light.....	32
Float.....	34
Diversion: Relay.....	34
Diversion: Solid State.....	36
Low Battery Disconnect.....	38
Remote.....	40
BACKLIGHT.....	41
EQ (Equalize).....	41
MISC-MISCELLANEOUS.....	44
ADVANCED.....	46
Snooze Mode.....	46
Wakeup Mode.....	47
MPPT Mode.....	47
Park Mpp.....	48
CHARGING RELATED SCREENS.....	49
Absorb Time.....	49
Rebulk Voltage.....	50

Vbatt Calibration.....	51
RTS Compensation.....	51
Auto Restart.....	52
Aux Polarity.....	53
Reset to Defaults?	53
(DATA) LOGGING	55
Clearing Total and Daily Stats	55
STATS	56
Secondary Stats Screen.....	57
MICRO-HYDRO, WIND TURBINE, AND FUEL CELL APPLICATIONS.....	58
ADVANCED MENU (Micro-Hydro)	59
Charge Controller ABBREVIATED MENU MAP	60
APPLICATION NOTES	61
Charge Controller EFFICIENCY vs. INPUT POWER GRAPH	62
UNDERSTANDING THE VARIOUS OPERATIONAL MODES.....	63
MATE-DISPLAYED CHARGE CONTROLLER STATUS MODE Screens.....	66
MATE-DISPLAYED CHARGE CONTROLLER STATUS METER Screens.....	67
MATE-DISPLAYED CHARGE CONTROLLER STATUS SETP(OINT) Screens.....	68
MATE-DISPLAYED Charge Controller ADVANCED SCREENS.....	68
ADVANCED MENU	69
EQ SCREENS	70
AUX SCREENS.....	70
ABBREVIATED MENU.....	71
TROUBLESHOOTING GUIDE.....	73
TYPICAL ARRAY SIZING GUIDE	76
STANDARD vs. AUSTRALIAN DEFAULT SETTINGS.....	77
WIRE DISTANCE CHART FLEXMAX 80.....	78
WIRE AND DISCONNECT SIZING FLEXMAX 80	80
WIRE AND DISCONNECT SIZING FLEXMAX 60	81
WIRING COMPARTMENT.....	82
MULTI-STAGE BATTERY CHARGING.....	83
BATTERY TEMPERATURE COMPENSATED VOLTAGE SET POINT	85
SUGGESTED BATTERY CHARGER SET POINTS	86
CALLING THE FACTORY FOR ASSISTANCE	87
WARRANTY INFORMATION	88
PRODUCT REGISTRATION AND OPTIONAL EXTENDED WARRANTY	90
EU DECLARATION OF CONFORMITY.....	91
OWNER'S SYSTEM INFORMATION	92

SCOPE

This manual provides safety guidelines and installation information for the FLEXmax 60 and FLEXmax 80 Charge Controller Maximum Power Point Tracking Charge Controllers. It does not provide information about specific brands of solar panels and supplies limited information on batteries. Contact the supplier or manufacturer of the solar panels or batteries for further information.

INTRODUCTION

The FLEXmax 60 and FLEXmax 80 Maximum Power Point Tracking Charge Controllers *

The OutBack Maximum Power Point Tracking Charge Controllers offer an efficient, safe, multi-stage recharging process that prolongs battery life and assures peak performance from a solar array. Each Charge Controller allows customized battery recharging. The Charge Controller features include:

- 80 amps maximum continuous output current up to 40° C without thermal derating for the FLEXmax 80 and 60 amps for the FLEXmax 60
- Engineered to work with 12, 24, 36, 48, and 60VDC battery voltages
- Backlit LCD display screen with 80 characters (4 lines, 20 characters per line)
- Last 128 days of operational data are logged for review
- Voltage step-down capability allowing a higher PV array voltage configuration
- Manual and auto-equalize cycle

The following are the maximum recommended wattage for the most common solar arrays under Standard Test Conditions (1000 watts per square meter to solar panel at 25° C or 77° F):

- 12VDC battery systems—up to 1250 watts (FLEXmax 80) or 800 watts (FLEXmax 60) of solar panels
- 24VDC battery systems—up to 2500 watts (FLEXmax 80) or 1600 watts (FLEXmax 60) of solar panels
- 36VDC battery systems—up to 3750 watts (FLEXmax 80) or 1200 watts (FLEXmax 60) of solar panels
- 48VDC battery systems—up to 5000 watts (FLEXmax 80) or 3200 watts (FLEXmax 60) of solar panels
- 60VDC battery systems—up to 6250 watts (FLEXmax 60) or 4000 watts (FLEXmax 60) of solar panels

Each Charge Controller also features Continuous Maximum Power Point Tracking (MPPT), which seeks out the maximum power available from a solar array and uses it to recharge the batteries. Without this feature, the solar array does not operate at the ideal operating voltage and can only recharge at the level of the battery voltage itself. Each Charge Controller continuously tracks the array's maximum operating power.

This manual covers the wiring, installation, and use of the Charge Controllers, including explanations of all the menus displayed on the LCD screen. Each Charge Controller is designed to seamlessly integrate with other OutBack components and can be remotely monitored and configured (up to 1000 feet) by the optional OutBack Power Systems MATE display (version 4.0.4 or greater).

FIRMWARE

This manual covers Charge Controller firmware version 001.009.001

*For simplicity's sake, both the FLEXmax 60 and FLEXmax 80 will be referred to in this manual as "Charge Controller or by the abbreviation "CC."

OUTBACK CHARGE CONTROLLER INSTALLATION GUIDELINES AND SAFETY INSTRUCTIONS

This product is intended to be installed as part of a permanently grounded electrical system as shown in the system configuration sections (see pages 12-15) of this manual. The following important restrictions apply *unless superseded by local or national codes*:

- The negative battery conductor should be bonded to the grounding system at only *one* point in the system. If a GFP is present, the battery negative and ground are not bonded together directly but are connected together by the GFP device when it is on. All negative conductor connections must be kept separate from the grounding conductor connections.
- With the exception of certain telcom applications, the Charge Controller should *never* be positive grounded (see page 61, Applications Notes).
- The Charge Controller equipment ground is marked with this symbol: 
- If damaged or malfunctioning, the Charge Controller should only be disassembled and repaired by a qualified service center. Please contact your renewable energy dealer/installer for assistance. Incorrect reassembly risks malfunction, electric shock or fire.
- *The Charge Controller is designed for indoor installation or installation inside a weatherproof enclosure. It must not be exposed to rain and should be installed out of direct sunlight.*

For routine, user-approved maintenance:

- Turn off all circuit breakers, including those to the solar modules, and related electrical connections before cleaning the air vents.

Standards and Requirements

All installations must comply with national and local electrical codes; professional installation is recommended. NEC requires ground protection for all residential PV installations

DC and Battery-Related Installation Requirements:

- All DC cables must meet local and national codes.
- Shut off all DC breakers before connecting any wiring.
- Torque all the Charge Controller's wire lugs and ground terminals to 35 inch-pounds (4 Nm).
- Copper wiring must be rated at 75° C or higher.
- Use up to 2 AWG (33.6 mm²) to reduce losses and ensure high performance of Charge Controller (smaller cables can reduce performance and possibly damage the unit).
- Keep cables together (e.g., using a tie-wrap) as much as possible.
- Ensure both cables pass through the *same* knockout and conduit fittings to allow the inductive currents to cancel.
- DC battery over-current protection must be used as part of the installation. OutBack offers both breakers and fuses for overcurrent protection.

WARNING - WORKING IN THE VICINITY OF A LEAD ACID BATTERY IS DANGEROUS.

BATTERIES GENERATE EXPLOSIVE GASES DURING NORMAL OPERATION. Design the battery enclosure to prevent accumulation and concentration of hydrogen gas in “pockets” at the top of the enclosure. Vent the battery compartment from the highest point to the outside. A sloped lid can also be used to direct the flow of hydrogen to the vent opening.

CAUTION - To reduce risk of injury, charge only deep-cycle lead acid, lead antimony, lead calcium, gel cell or absorbed glass mat type rechargeable batteries. Other types of batteries may burst, causing personal injury and damage. *Never* charge a frozen battery.

PERSONAL PRECAUTIONS DURING INSTALLATION

- Someone should be within range of your voice to come to your aid if needed.
- Keep plenty of fresh water and soap nearby in case battery acid contacts skin, clothing, or eyes.
- Wear complete eye protection. Avoid touching eyes while working near batteries. Wash your hands with soap and warm water when done.
- If battery acid contacts skin or clothing, wash immediately with soap and water. If acid enters an eye, flood the eye with running cool water at once for at least 15 minutes and get medical attention immediately following.
- Baking soda neutralizes lead acid battery electrolyte. Keep a supply on hand in the area of the batteries.
- **NEVER** smoke or allow a spark or flame in vicinity of a battery or generator.
- Be extra cautious to reduce the risk of dropping a metal tool onto batteries. It could short-circuit the batteries or other electrical parts that can result in fire or explosion.
- Remove personal metal items such as rings, bracelets, necklaces, and watches when working with a battery or other electrical current. A battery can produce a short circuit current high enough to weld a ring or the like to metal, causing severe burns.



FLEXmax™ 80



FLEXmax™ 60

1. Installing the Charge Controller

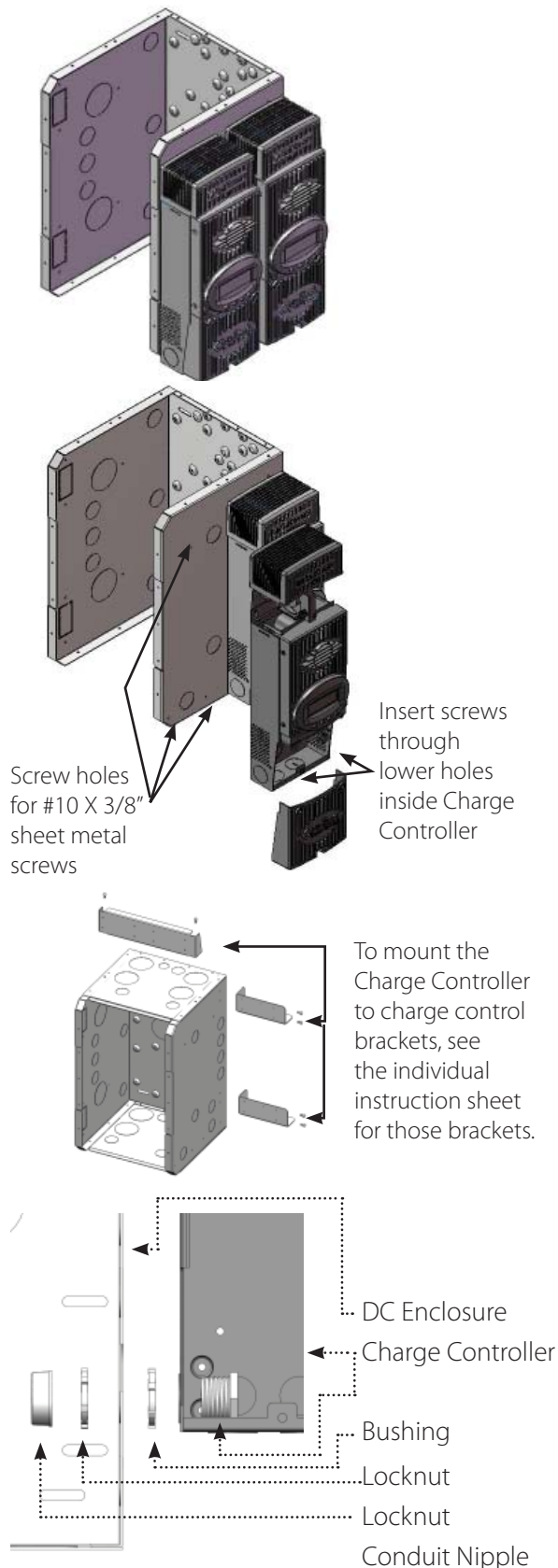

The Charge Controller is designed to attach directly to OutBack's FLEXware 500 DC and FLEXware 1000 DC enclosures (FLEXware 500 shown) or attach to its own charge control brackets (FW-CCB, FW-CCB2, and FW-CCB2T).

NOTE: Install the Charge Controller in an upright position out of direct sunlight.

To mount directly to a FLEXware DC enclosure:

- Remove the fan cover and bottom cover from the Charge Controller.
- Insert a #10 X 3/8" sheet metal screw in the top hole on the side of the DC enclosure. This will act as a hanging screw for the keyhole slot at the top center of the Charge Controller.
- Hang the Charge Controller on the top screw and line up its bottom two screw holes with the holes on the enclosure.
- Insert a #10 X 3/8" sheet metal screw through each hole and tighten against the enclosure (screws are included with each DC enclosure).
- Keep the cover off until wiring is completed.

The Conduit Nipple Assembly creates a sealed pass-through from the Charge Controller to the enclosure

Mounting to Plywood

Use 1 5/8" wood screws to secure the Charge Controller at the top slotted holes and other interior lower holes as needed, making sure the unit is straight and level.

2. Determining Wire Sizes

Open Circuit Voltage/Wire and Disconnect Size

Maximum Open Circuit Voltage (VOC)

- VOC is the *unloaded* voltage generated by the solar array.
 - Greater than 145VDC → Charge Controller suspends operation to protect components
 - 150VDC → max open circuit voltage with the coldest environment

NOTE: Although the Charge Controller shuts down at a voltage greater than 145VDC, it can withstand up to 150VDC from the array; anything higher than 150VDC will damage the Charge Controller).

- As every brand of panel is different, be sure to know the manufacturer's specifications.
- Weather conditions vary and will affect panel voltage.
 - Hot weather: lower open circuit voltage/lower maximum power point voltage
 - Cold weather: higher open circuit voltage/higher maximum power point voltage
 - Allow for ambient temperature correction using the following table:

25° to 10° C (77° to 50° F)	multiply VOC by 1.06
9° to 0° C (49° to 32° F)	multiply VOC by 1.10
-1° to -10° C (31° to 14° F)	multiply VOC by 1.13
-11° to -20° C (13° to -4° F)	multiply VOC by 1.17
-21° to -40° C (-5° to -40° F)	multiply VOC by 1.25

- **Check the PV array voltage before connecting it to the Charge Controller (see page 76)**

Wire and Disconnect Sizing

FLEXmax 80

- The output current limit of the FLEXmax 80 is 80 amps
- Use a minimum of 4 AWG (21.15 mm²) wire for the output between the FLEXmax 80 and the battery bus bar conductors
- Install OutBack OBB-80-150VDC-PNL breakers for disconnect and overcurrent protection
- The largest PV array that can connect to a Charge Controller must have a rated short-circuit current of 64 amps or less under STC (Standard Test Conditions).

FLEXmax 60

- The output current limit of the FLEXmax 60 is 60 amps
- Use a minimum of 6 AWG (13.3 mm²) wire for the output between the FLEXmax 60 and the battery bus bar conductors
- Install OutBack OBB-60-150VDC-PNL or OBB-80-150VDC-PNL breakers for disconnect and overcurrent protection
- The largest PV array that can connect to a Charge Controller must have a rated short-circuit current of 48 amps or less under STC (Standard Test Conditions).

NOTE: Input conductors and circuit breakers must be rated at 1.56 times the short-circuit current of the PV array. OutBack 100% duty continuous breakers only need to be rated at 1.25 times the short-circuit current.

- Please see the wire Distance Chart and complete Wire and Disconnect Sizing on pages 78-81 for other suitable conductor/wire sizing.

3. Charge Controller Wiring Connections

Figure 1 Charge Controller wiring compartment

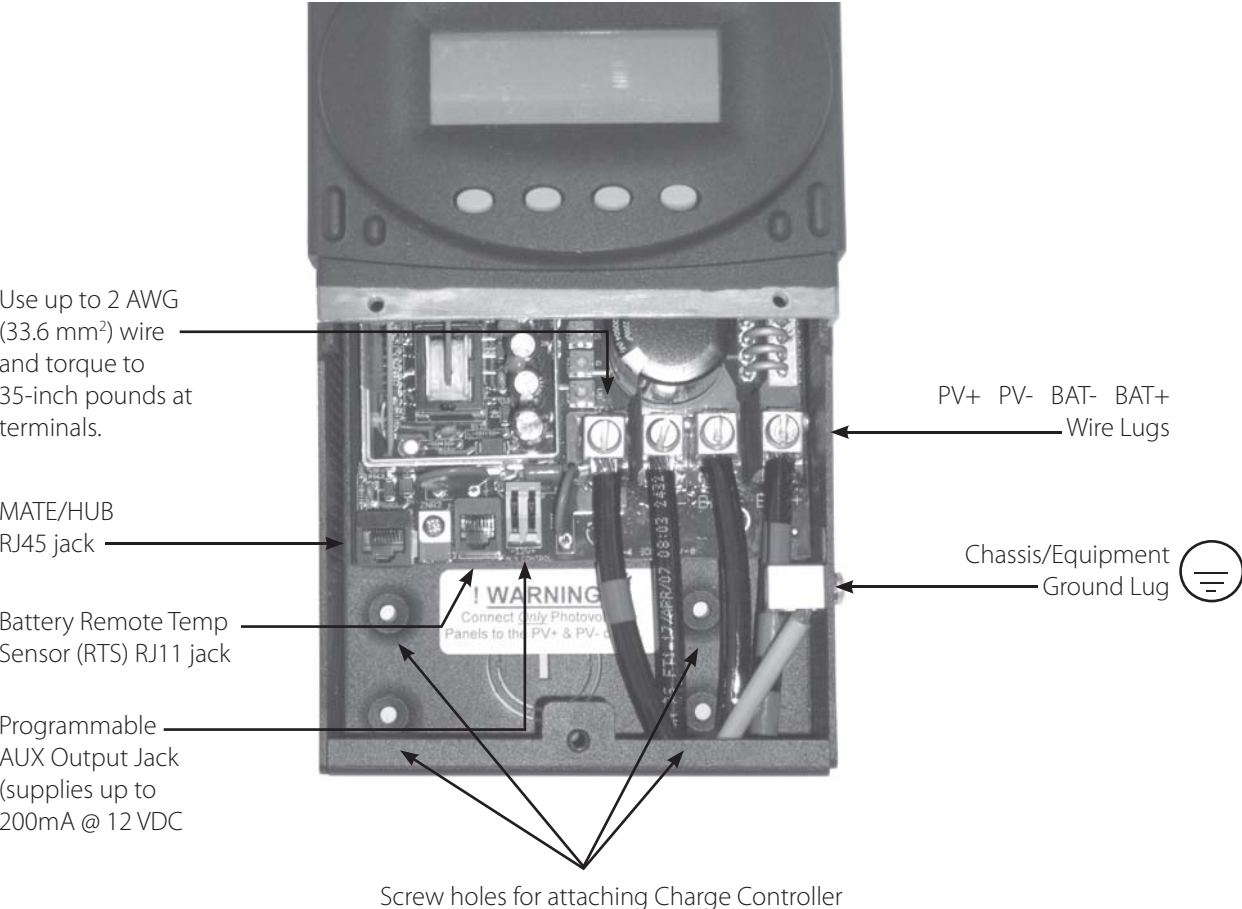

The PV (-) and BAT (-) terminals are connected internally. Only one negative wire may be needed to connect to the (-) wire lugs if the PV - and BAT- conductors are bonded at the negative bus bar. See Figures 2 and 3 for sample wiring diagrams. See *Wire and Disconnect Sizing on page 80 for suitable conductor/wire sizing.*

NOTES:

- Each Charge Controller requires its own PV array. DO NOT PARALLEL Charge Controller PV+ and PV- TERMINALS ON THE SAME ARRAY!
- An optional battery Remote Temperature Sensor (RTS) is recommended for accurate battery recharging (only one RTS is needed for multiple OutBack Series Inverter/Chargers and Charge Controller units when an OutBack HUB and a MATE are parts of the system). When one RTS is used, it must be connected to the component plugged into the Port 1 of the HUB.

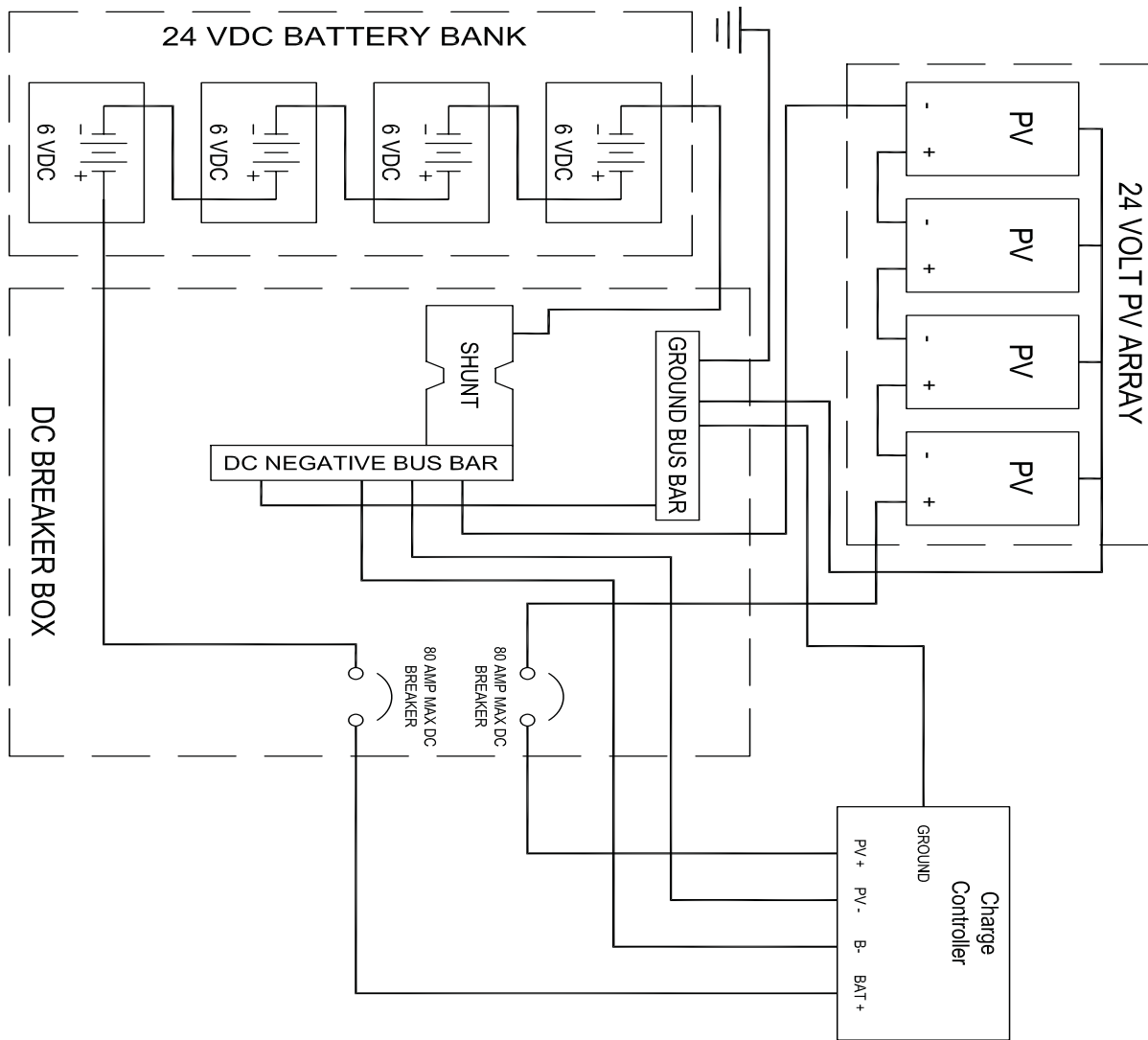

Figure 2 Single Charge Controller wiring diagram with 24 volt PV array

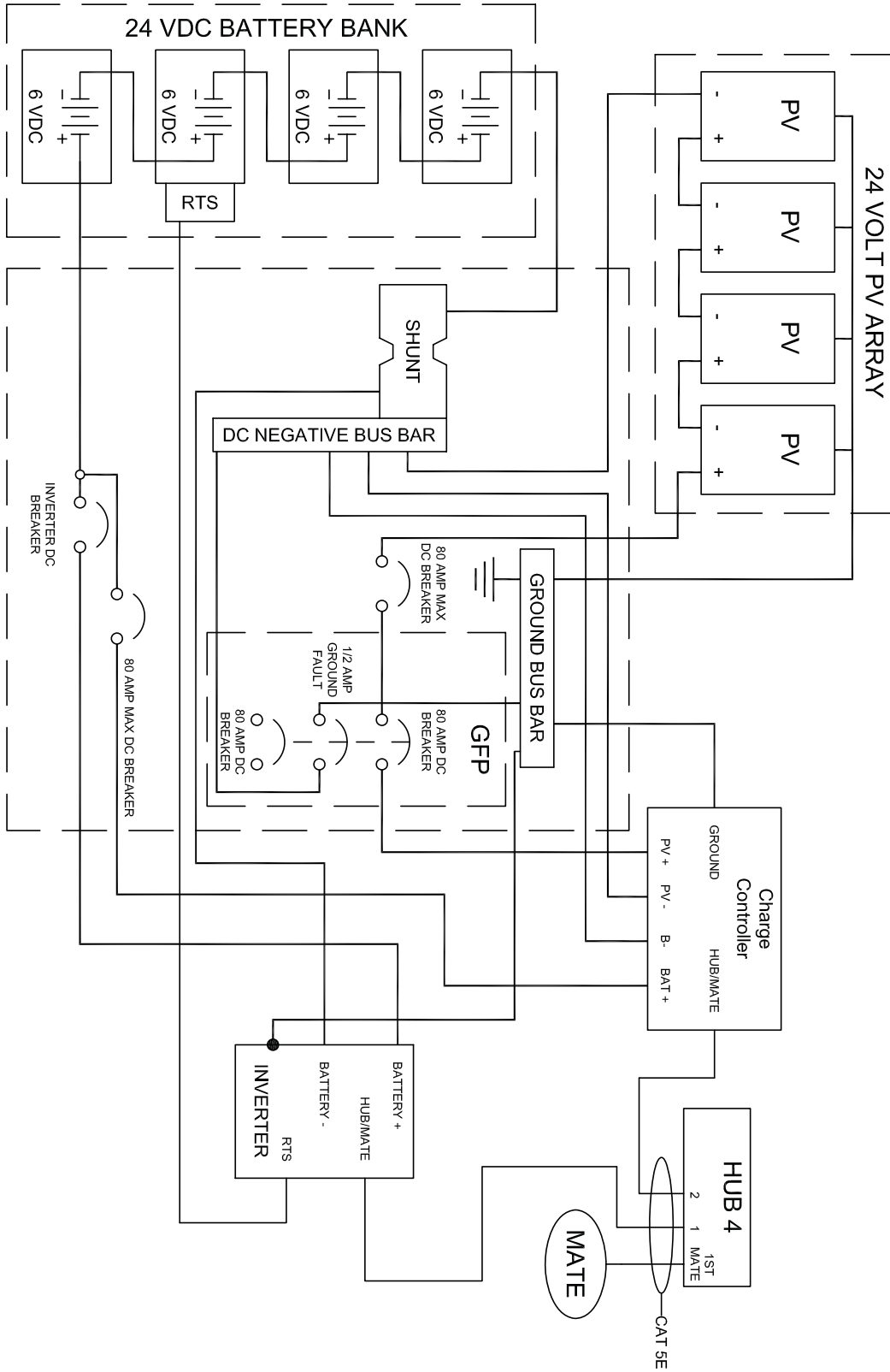
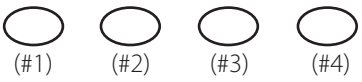



Figure 4 Charge Controller with PV array ground fault protection wiring diagram.

How to Read the Charge Controller Screen Diagrams

Soft keys:  (#1) (#2) (#3) (#4)

Solid black indicates key is to be pressed: 

Down arrow will lead to the next screen: 

Up arrow points to one or more keys that will change a value: 

The keys correspond to any text immediately above them.

4. Powering Up

The Charge Controller power-up sequence first activates the unit and the *SELECT VERSION* screen (to determine a choice of English, Espanola, or Australian settings). A *SYSTEM VOLTAGE* screen soon follows. However, when it auto-detects the system's battery voltage, in some instances the Charge Controller might not reflect the correct system voltage (e.g., if a 36VDC system falls to a voltage range that could be misread as a 24VDC system). The *SYSTEM VOLTAGE* screens allow the user to adjust the Charge Controller to the correct voltage.

NOTE: Be sure the PV input and battery breakers are off before starting the power-up sequence.

OFF SCREEN (this screen is initially blank at power up)



With the PV array and battery breakers off, turn on the battery breaker.



NOTE: The battery voltage must be at least 10.5V or higher to power up the Charge Controller. If the screen reads *Low Battery Voltage*, please see the Troubleshooting Guide on page 73.

Power Up Screen

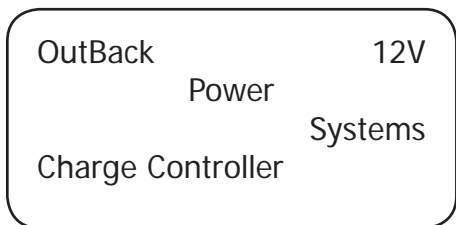

The Charge Controller will show the system battery voltage in the upper right corner of the screen. The *Select Version* screen appears next.

NOTE:

- The Charge Controller's default setting is for a 12 VDC battery.
- Change the setting after powering up the Charge Controller if a different battery voltage is used.
- The PV array voltage—which must not exceed 150 VDC open circuit—is automatically detected.



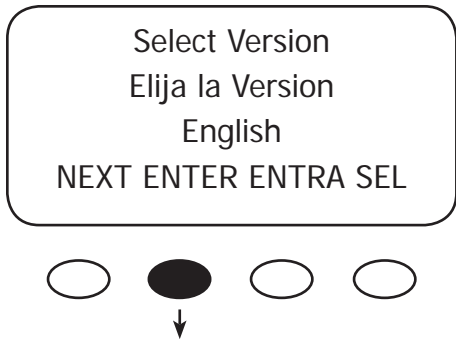

The Charge Controller screens are offered in English (standard screens) and Spanish. For Australian users, some of the charging values are of different voltages and the Charge Controller accommodates these. By pressing the **<NEXT>** soft key, the user can choose English, Australia, or Espanola versions of the screens. After pressing the **<NEXT>** soft key, a password must be entered before selecting the screen version.

Password Screen

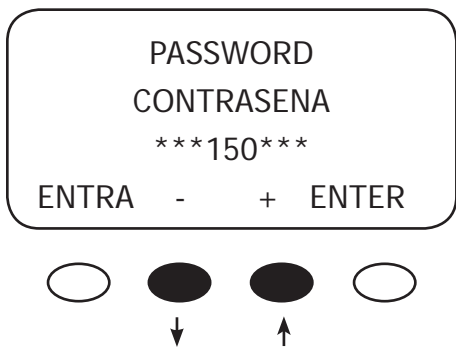

Press the “-” soft key until the password 141 shows on the screen. Press the **<ENTER>** soft key to return to the *Select Version* screen.

NOTE: 141 is the password for all OutBack products.

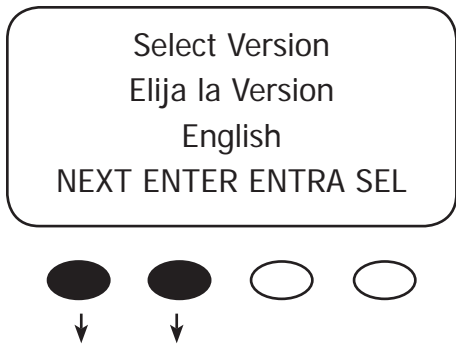

Press the **<NEXT>** to choose the desired screen version. Press the **<ENTER>** soft key to view the version confirmation screen.

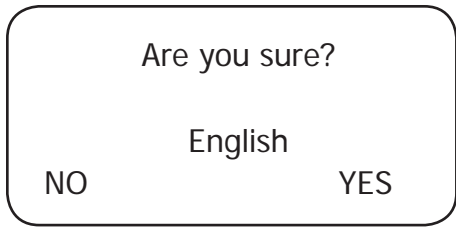

System Voltage Screen

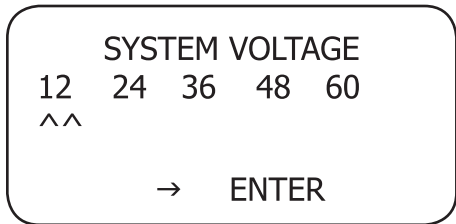

Verification Screen

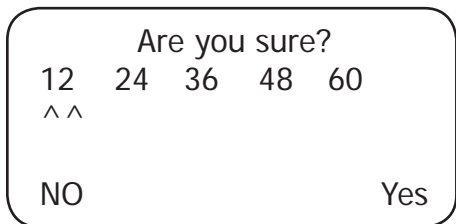

Press the **<YES>** soft key to confirm your choice or **<NO>** to return to the *SELECT VERSION* screen.

The Charge Controller auto detects the system's battery voltage. To confirm this voltage, press the **<ENTER>** soft key. If incorrect, press the "→" soft key to select a battery voltage. The Charge Controller's default values are based on a 12VDC system. Selecting a higher voltage system will change all the default values (e.g., the values will double with a 24VDC system, triple with a 36 VDC system, etc.). "^^" indicates the chosen voltage. The Charge Controller will automatically accept the selected battery voltage if left unattended for 5 minutes in this screen. After choosing the voltage, press the **<ENTER>** soft key to proceed.

Press the **<YES>** soft key to proceed if the selected battery voltage is correct. If incorrect, press **<NO>** to re-enter the correct voltage. The **<YES>** soft key will open the STATUS screen.

NOTE: Repeating the Powering Up sequence resets the Charge Controller Charge Controller to its factory default settings (see page 77).

5. Status Screen

The *STATUS* Screen displays system information. See page 63 for detailed information of the different Operational Modes. The optional OutBack MATE displays CC (Charge Controller) STATUS screens for convenient distant viewing from the installation location of the Charge Controller. Please see pages 66-68 to view the Charge Controller screens displayed on the MATE.

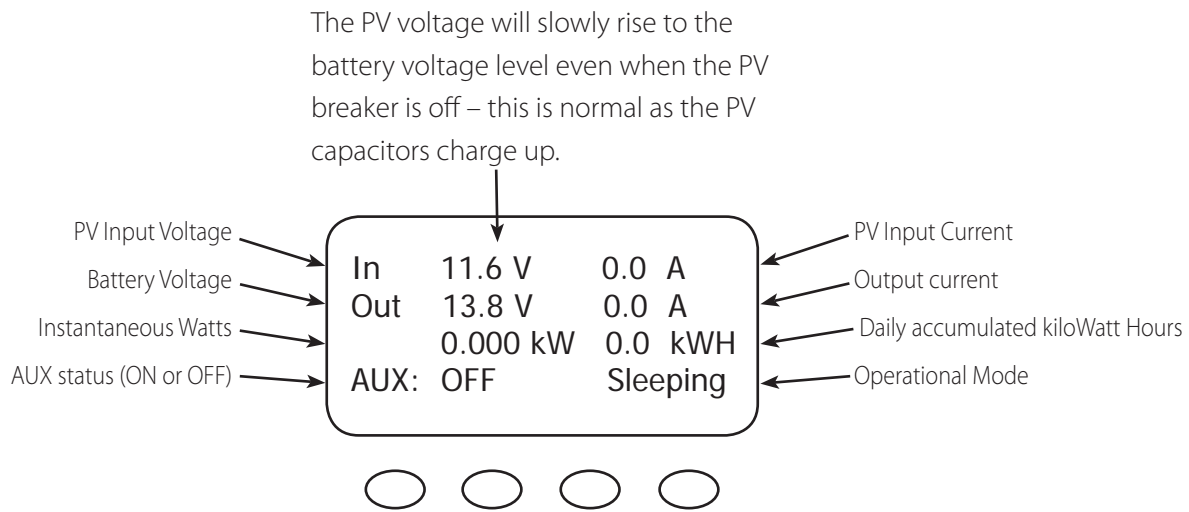

NOTE:

- Pressing the first soft key opens the MAIN Menu screen.
- Pressing second soft key opens the End of the Day summary menu/logging.

6. End of Day Summary Screen

The *End of Day* summary screen appears after one hour of continuous sleeping. This screen can be opened anytime by pressing the second soft key while in the STATUS screen, providing a summary up to that point.

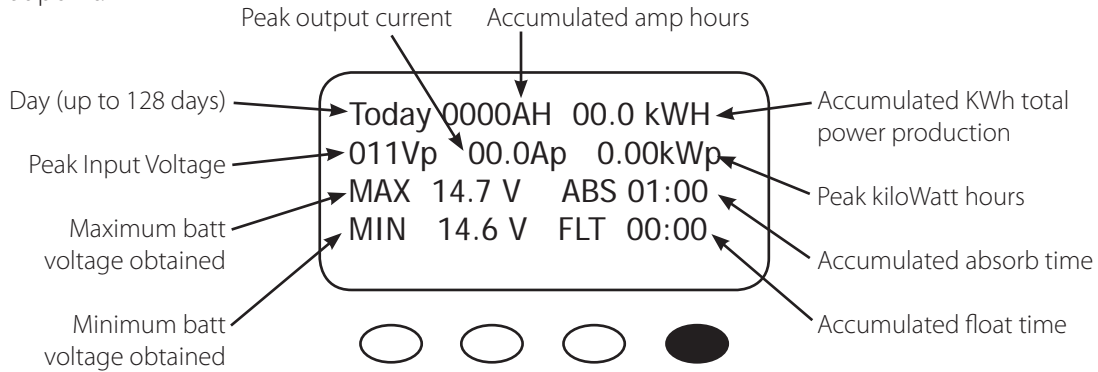

NOTE:

- Pressing the first soft key opens the STATUS screen.
- Pressing the second soft key brings up the CLEAR LOG screen.
- Pressing the third soft key shows the previous day's summary; continually pressing this soft key will bring up additional past summaries up to 128 days.
- Pressing the fourth soft key will bring up summary for the 128th day back.

7. Recharging Using the PV Array

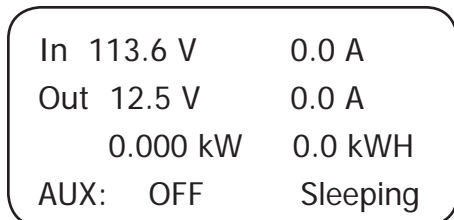

Turn the PV input breaker on. The Charge Controller automatically detects the PV input voltage.

(NOTE: If PV voltage registers "000V" when the breaker is on, please check the polarity of the PV wires.)

The Charge Controller enters a "Wakeup" stage, transitions to "Tracking" and prepares to charge the batteries by tracking the maximum power point of the solar array.

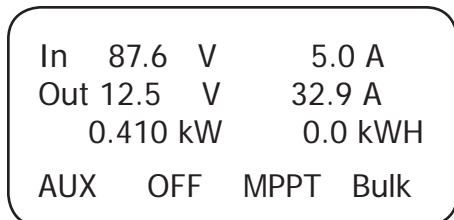

During the Charge Controller's initial tracking, the input source (e.g., solar) is gradually loaded from the open circuit voltage (VOC) to one-half of the VOC. Within this range, the Charge Controller seeks the maximum power point. When the Charge Controller goes into Re-Cal, Auto Restart, Wakeup, or RSTRT (restart) modes, among other conditions, it performs an initial tracking.

8. Accessing the MAIN Menu

The *MAIN* Menu allows the user to adjust and calibrate the Charge Controller for maximum performance. From the *STATUS* screen, press the first soft key on the left to open the *MAIN* Menu screen.

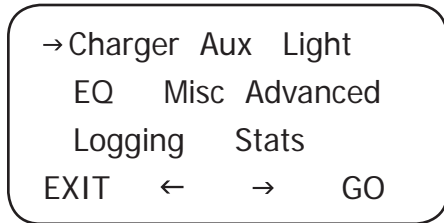

Press <<> or <=> to move the "→" to the left of the desired screen. The arrow allows access to any screen to its right.

Press the <GO> soft key after aligning the arrow in front of the selected menu choice.

Pressing the <EXIT> soft key in the *MAIN* Menu returns to the *STATUS* screen.

From the *MAIN* Menu, a user can choose among the following Charge Controller functions by aligning the arrow:

- **Charger—CHARGER SETUP**
 - Adjusts the Current Limit, Absorb, and Float recharging voltage set points
- **Aux—AUX OUTPUT CONTROL**
 - Secondary control circuit for a vent fan, error alarm, and other system-related additions
- **Light—BACKLIGHT CONTROL**
 - Adjusts the backlighting of LCD screen and soft key buttons
- **EQ—BATTERY EQUALIZE**
 - Activates battery equalization recharging (manually or automatically)
- **Misc—MISCELLANEOUS**
 - Additional settings and service information
- **Advanced —ADVANCE MENU**
 - Optimizing/fine-tuning the Charge Controller (these are advanced Menus that should be left alone until the user has a good working knowledge of the Charge Controller and its operations)
- **Logging—DATA LOGGING**
 - Displays recorded power production information
- **STATS—Statistics**
 - Displays recorded peak system information and cumulative kilowatt hours and amp hours

7. Charger Set-Up

This screen allows changes to the Charge Controller's recharging voltage set points—Current Limit, Absorb and Float (for an explanation of battery charging, see pages 83-84):

- The presently selected numerical value will have an arrow "→" to the left of it.
- Pressing <↓> selects the value to be changed.
- You *may* need to re-enter the password to change these settings.
- The default charger output current limit setting is 80 amps for the FM80 and 60 amps for the FM60. This setting is adjustable from 5-80 amps. An appropriate breaker must be used between the battery and the Charge Controller.
- Change Absorbing and Float set points using this screen if the battery manufacturer's recommendations are different than the default values. Otherwise, see page 8 for suggested recharging voltage set points.

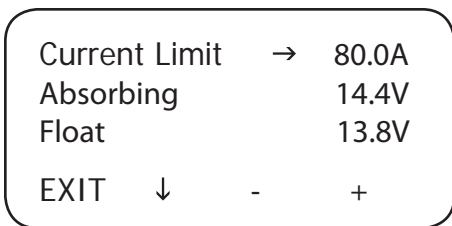
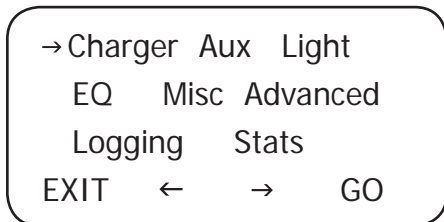

From the MAIN screen, press <←> or <→> to move the "→" to the left of the *Charger* function and then press the <GO> soft key. This will open the Charger Set-Up screen.

NOTE: If a battery remote temperature sensor (RTS) is used, set the ABSORB and FLOAT setting voltage based on a 25°C / 77°F setting. These are typically the manufacturer's set points (always consult the battery manufacturer's recommendations). RTS compensated voltage values can be viewed in the Advanced menu screen under the RTS Compensation heading. If an RTS is not in use, please see the Non-Battery Temperature Compensated System values (page 85) and adjust the ABSORB/FLOAT values accordingly.

8. AUX Mode and Its Functions

The AUX is a secondary control circuit—essentially, a small power supply that provides a 12VDC (up to 200 milliamps) output current. It is either active (12VDC on) or inactive (0VDC). Most AUX modes or functions are designed for specialized applications and are infrequently used.

- To access the AUX MODE from the MAIN Menu, press the **<→>** soft key until the arrow is in front of the Aux selection (see next page).

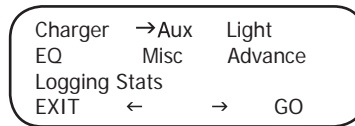

- A 200 milliamps or less, 12VDC/2.4W device can be wired directly to the AUX terminal; higher output DC loads require a 12VDC coil relay—also rated up to 200 milliamps or less for the DC coil—which itself is connected to the AUX output. An internal, re-settable Positive Temperature Co-efficient (PTC) fuse protects the AUX internal components from overcurrent or a short circuit.
- For certain AUX control applications the use of a solid state relay is preferred. This is particularly beneficial with applications such as the Diversion mode where fast switching (often called PWM control) allows a more constant battery voltage to be maintained. Both DC and AC load switching solid state relays are widely available from many sources. Eurotherm and Power-IO are two suggested solid state relay manufacturers.
- Only one AUX MODE can operate at a time (*even if other modes have been preset*).
- See Figure 5, page 36, for an AUX set-up wiring diagram example.

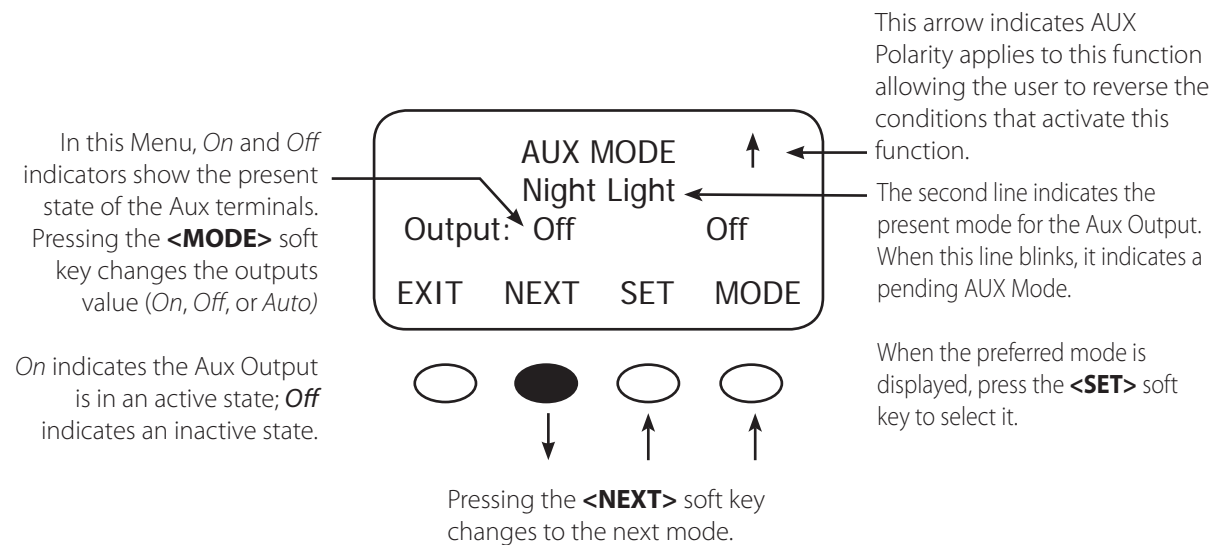

TERMS

- AUX MODE: what is displayed on the Menu
- Aux Output: 12VDC is either available or unavailable at the Aux Terminal
- Aux Terminal: the jack to which a relay is wired

AUX MODE Menu Path

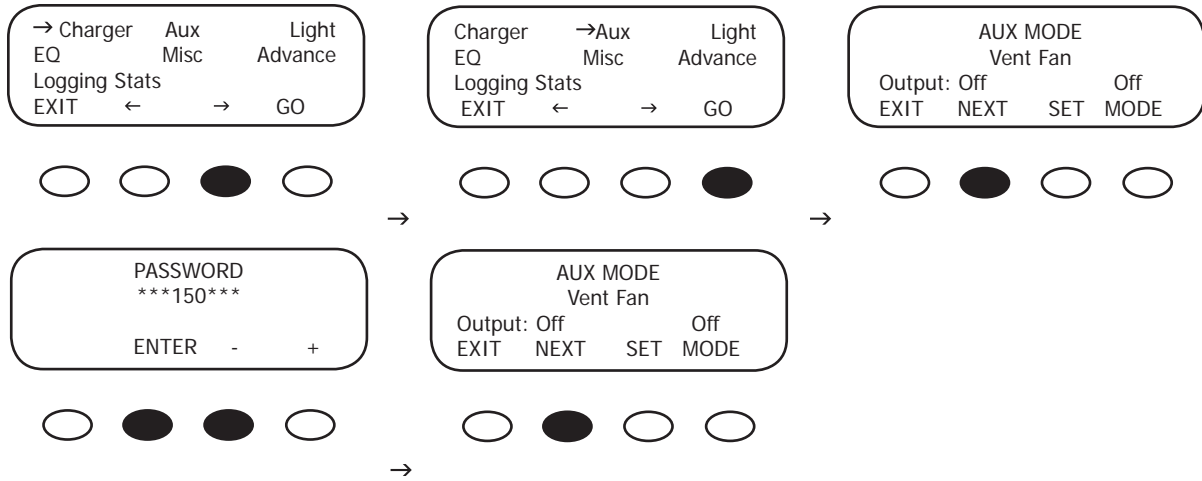

To access the AUX Output Menu:

- Press the first soft key once from the STATUS Menu to open the MAIN Menu.
- Press either of the arrow soft keys until the “→” is to the left of *Aux*.
- Press the **<GO>** soft key. If more than ten minutes have passed since any activity, the PASSWORD screen becomes active, requiring the user to input the 141 PASSWORD and press **<ENTER>**.
- Pressing the **<NEXT>** soft key scrolls through the AUX functions.
- The most commonly used AUX modes are *Vent Fan*, *Low Battery Disconnect* and *Diversion*.

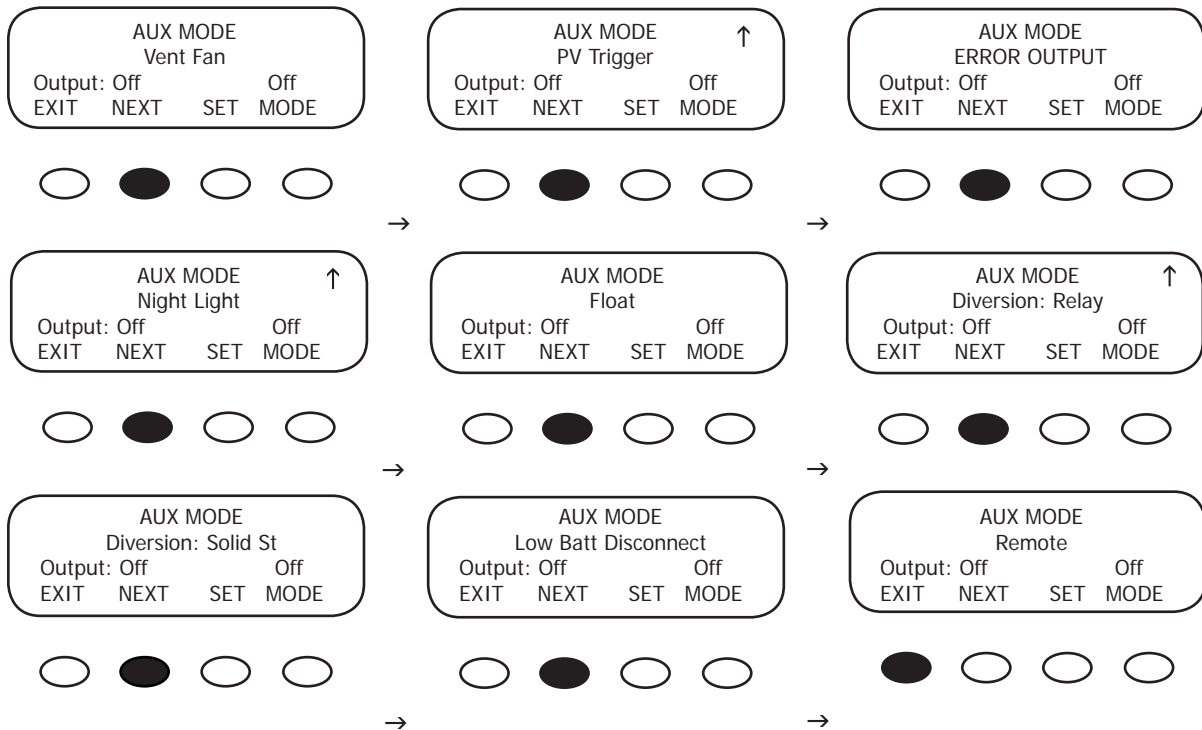

AUX modes in order of appearance on the Charge Controller display:

- *Vent Fan* • *PV Trigger* • *Error Output* • *Night Light* • *Float* • *Diversion Relay*
- *Diversion Solid State* • *Low Battery Disconnect* • *Remote*

NOTE: All AUX functions can be manually activated in *On*, *Off*, or *Auto* mode. In *Auto* mode, the function will automatically activate when a user-determined value is met and deactivate or shut down when other conditions described here, such as a certain amount of time passing, occur.

When an AUX MODE is in AUTO, 12VDC is available at the AUX terminals and a condition, such as a voltage set point, is met. Other modes can be programmed in lieu of the specific ones listed here, but the *Vent Fan* mode is most easily changed (e.g., to activate an alarm instead of a fan). Here are the default AUX modes:

- **Vent Fan**— when the *Vent Fan* voltage set point is exceeded, the vent fan will run for at least 15 seconds (the fan helps remove hydrogen from battery enclosure), even if the set point is exceeded for only a few seconds due to a surge. If the set point is exceeded for longer than 15 seconds, the fan will stay on until the voltage drops below the set point. It then takes 15 seconds before the fan shuts off. This is an optional external fan and not to be confused with the Charge Controller's internal, thermally activated fan which cools the unit.
- **PV Trigger***—activates an alarm or relay (that disconnects the array); when the PV input exceeds the user-determined voltage set point (to avoid damage, do not go over 150VDC), the PV Trigger disconnects after a minimal adjustable amount of *Hold Time*.
- **Error Output**—useful for monitoring remote sites, switches to the *Off* state if the Charge Controller has not charged the batteries for 26 hours or more (not an audible alarm, only displayed as a printed message on Charge Controller AUX Menu) or the battery voltage has fallen below a user-determined set point for 10 continuous minutes. In the **No Error** state, the AUX output is on.
- **Night Light***—after the PV voltage is below a threshold voltage for a user-determined time period, a user-provided light illuminates as long as the Charge Controller remains sleeping or as determined by the user-established time limit.
- **Float**—powers a load if the Charge Controller is producing power in the *Float* stage
- **Diversion Relay***—diverts excess power away from batteries when a wind or hydro generator is connected directly to the batteries.
- **Diversion Solid St**—same as *Diversion Relay*, but applies when a solid state relay is used rather than a mechanical relay
- **Low Batt Disconnect**—activates/deactivates the AUX load(s) when a user-determined voltage and time levels are reached.
- **Remote**—allows OutBack MATE control of the AUX MODE (see MATE manual for details).

* These functions support AUX polarity.

9. Programming the AUX MODES

VENT FAN

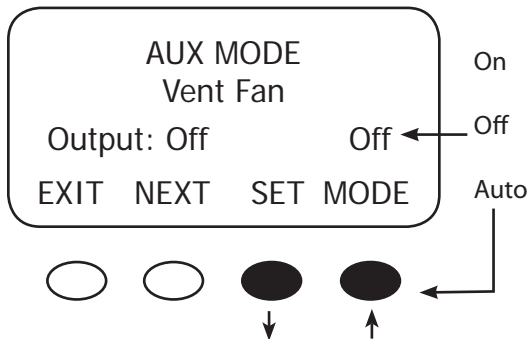

Press the **<MODE>** soft key to manually activate or deactivate (*On* or *Off*) the *Vent Fan*; if set to *Auto*, the *Vent Fan* will turn on when a user-determined voltage is met. Press the **<SET>** soft key to view the *Vent Fan* screen. To view other screens, continue to press the **<NEXT>** soft key.

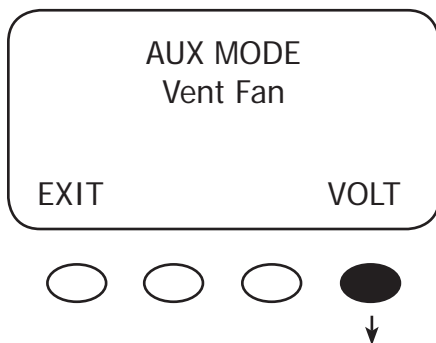

The *Vent Fan* helps remove hydrogen from the battery box. The ventilation fan referred to here is not the same as the Charge Controller cooling fan. Press the **<VOLT>** soft key to determine the battery voltage that will activate the AUX MODE and start the fan.

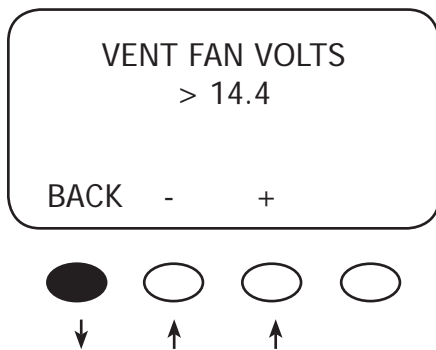

Adjust the voltage level using the **<->** and **<+>** soft keys. Press the **<BACK>** soft key to return to the *Vent Fan* screen.

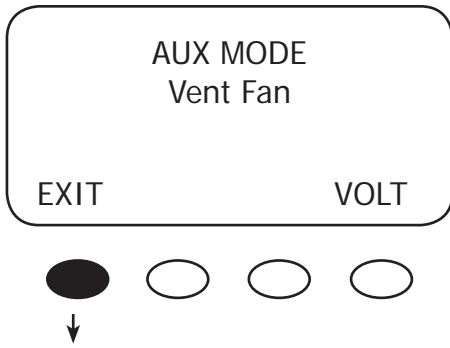

Press the **<EXIT>** soft key return to the main *Vent Fan* screen.

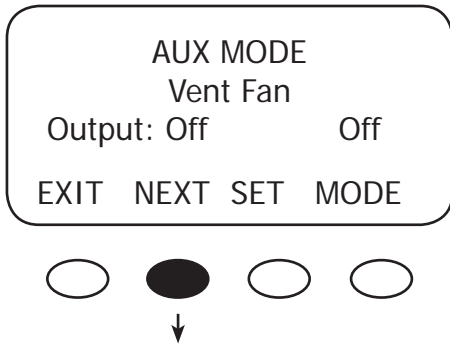

Press the **<NEXT>** soft key to view the *PV Trigger* screen

PV TRIGGER

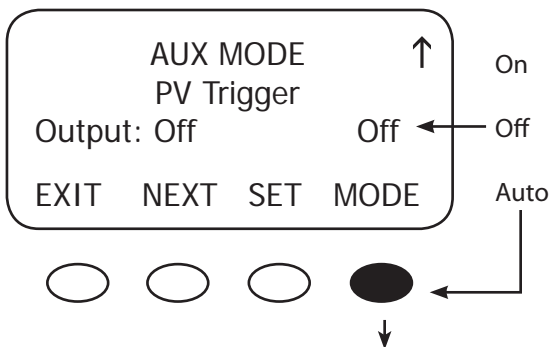

When the PV input exceeds the user-determined VOLT set point, the *AUX MODE PV Trigger* activates in Auto Mode. Press the **<MODE>** soft key to establish another *PV Trigger* mode (*On*, *Off*, or *Auto*).

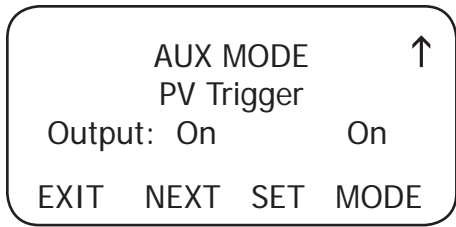

Press the **<SET>** soft key to open the *PV Trigger's TIME* and *VOLT(age)* set menus.

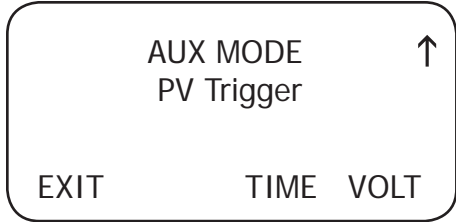

To adjust the voltage, press the **<VOLT>** soft key.

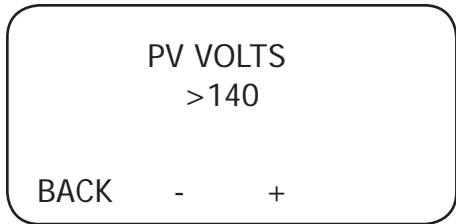

Adjust the voltage within a range of 20V-145V by pressing the **<->** or **<+>** soft key. When finished, press the **<BACK>** soft key to return to the *PV Trigger* screen

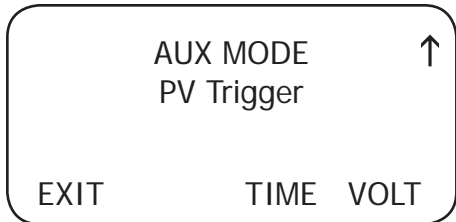

To adjust the minimum amount of time the PV voltage must remain high before deactivating the *AUX MODE*, press the **<TIME>** soft key.



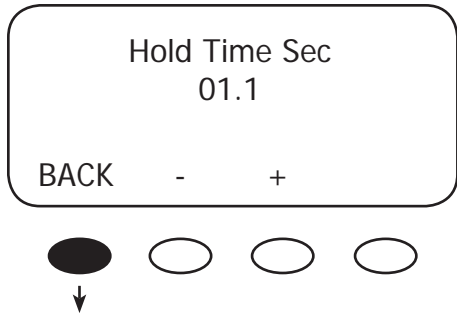

Press the **<->** or **<+>** soft key to adjust the Hold Time, then press the **<BACK>** soft key to return to the *PV Trigger* screen. In this example, the *AUX MODE* will remain active for 1.1 seconds after the PV voltage is below the *PV Trigger* voltage before deactivating the *PV Trigger* and reconnecting to the array.

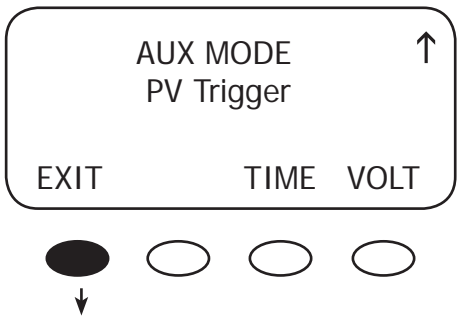

Press the **<EXIT>** soft key to return to the initial PV Trigger screen

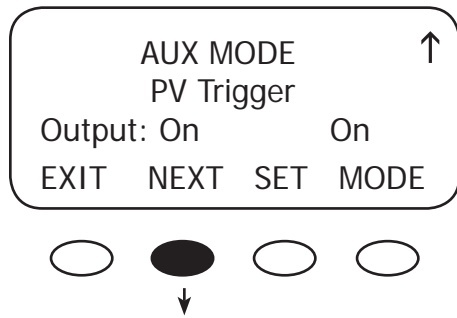

Press the **<NEXT>** soft key to view the *ERROR OUTPUT* screen.

ERROR OUTPUT

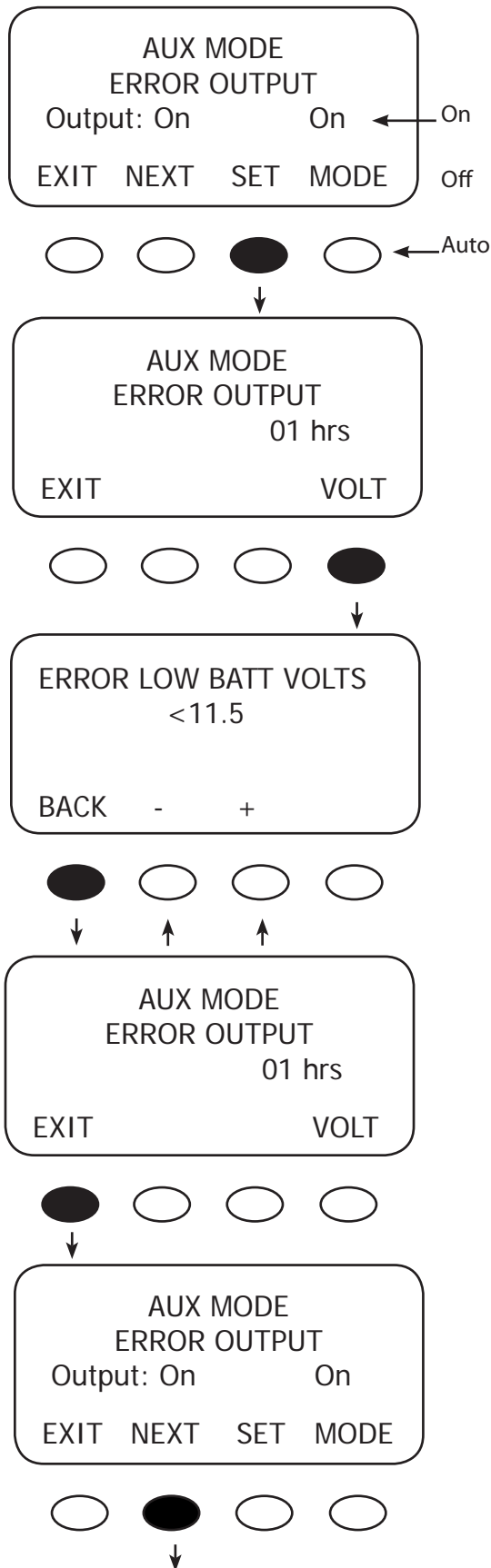

The *ERROR OUTPUT* default state is *On*, meaning 12 VDC is present at the AUX terminal. If the Charge Controller has not charged the batteries for 26 hours or more continuously, the inaudible *ERROR OUTPUT* goes into an *Off* state. The *ERROR OUTPUT* is intended for remote locations to signal (e.g., a telecommunication signal to a computer) when the Charge Controller has not charged the battery for 26 hours or more. Press the **<SET>** soft key to advance to the *ERROR OUTPUT* volt screen.

The *ERROR OUTPUT* screen displays the number of hours the Charge Controller has not been producing any power (the number of hours in *Sleep Mode*). Press the **<VOLT>** soft key to adjust the *ERROR LOW BATT VOLTS* screen.

User-determined value—not less than 10V—will trigger an alarm or, through a user-supplied modem, send a signal from a remote installation indicating the battery charge has reached this value. This informs the user of a low battery problem. Use the **<->** and **<+>** soft keys to change this value. Press the **<BACK>** soft key to return to the *AUX MODE ERROR OUTPUT* screen.

Press the **<EXIT>** soft key to bring up the original *ERROR OUTPUT* screen.

Press the **<NEXT>** soft key to view the *Night Light* screen.

NIGHT LIGHT

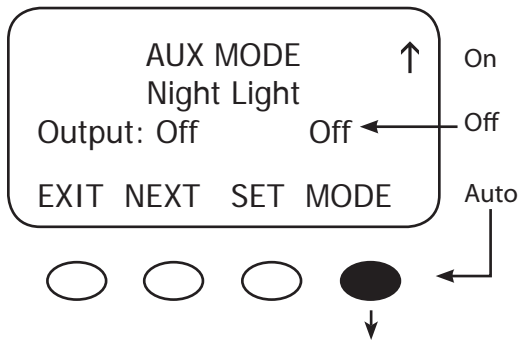

The *Night Light* illuminates a user provided low-wattage light when the PV voltage falls below a user-determined voltage. *Off* is the default value. Press the **<MODE>** soft key to change the *Night Light* MODE (*Off*, *On*, or *Auto*).

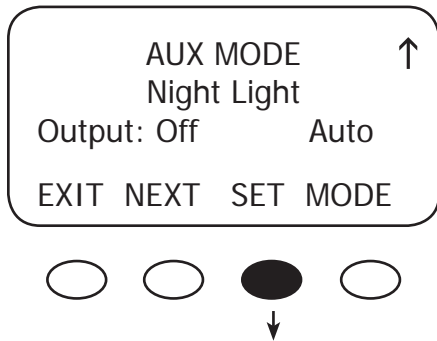

This example shows *Auto* MODE selected. Press the **<SET>** soft key to open the Hysteresis and PV Voltage screens.

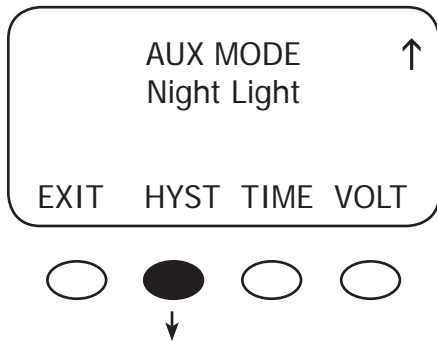

Press the **<HYST>** soft key to open the *On Hysteresis Time* screen.

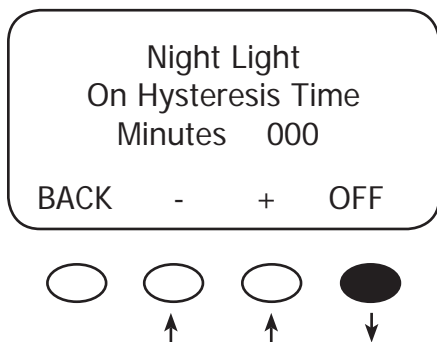

Use the **<->** and **<+>** soft keys to adjust the time required for the PV input voltage to be below the threshold voltage before the *Night Light* is enabled. Press the **<OFF>** soft key to view the *Off Hysteresis Time* screen.

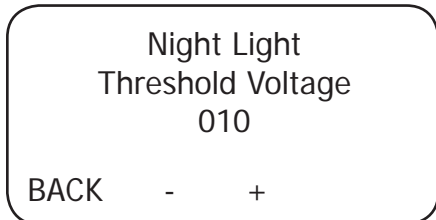
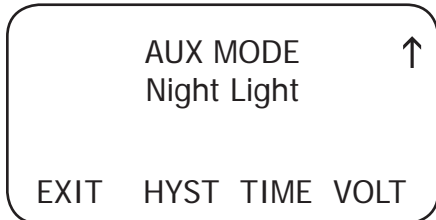
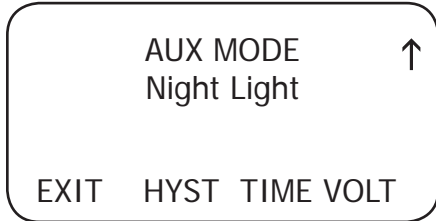
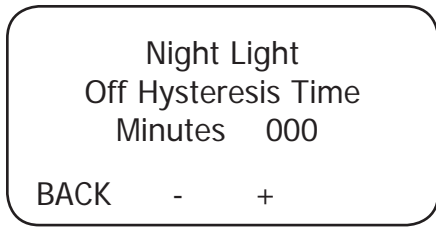

Use the <-> and <+> soft keys to adjust the time required for the PV input voltage to be above the threshold voltage before the *Night Light* is disabled. Press the <BACK> soft key twice to return to the *Night Light* screen.

Press the <TIME> soft key to adjust the length of time the *Night Light* remains on. If the time is set to 0, the *Night Light* remains on until the off condition is met.

Use the <-> and <+> soft keys to adjust the number of hours the *Night Light* remains on. Press the <BACK> soft key to return to the previous *Night Light* screen.

Press the <VOLT> soft key.

Press the <-> or <+> soft keys to adjust the *Threshold Voltage* value. When finished, press the <BACK> soft key to return to the *Night Light* screen.

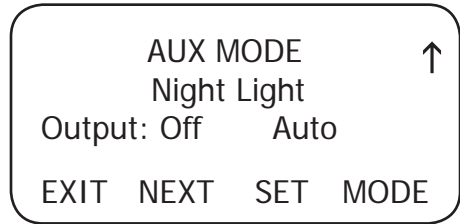
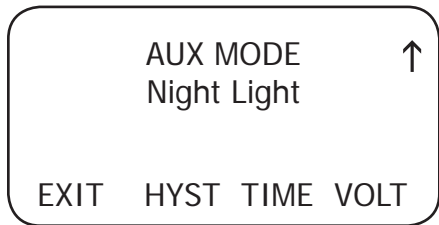

FLOAT

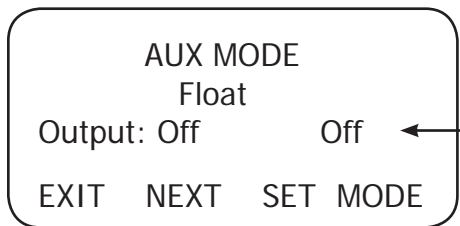

On
Off
Auto



RELAY

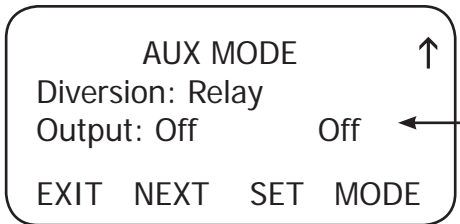

On
Off
Auto



Press the **<EXIT>** soft key to return to the *Night Light* AUX mode.

Press the **<NEXT>** soft key to view the *AUX Float* screen.

The *AUX MODE* is active when the Charge Controller is in *Float* and producing power. Press the **<NEXT>** soft key to advance to the *Diversion* screen.

When external DC sources (wind, hydro) are directly connected to a battery bank, any excess power should be sent to a diversion load, such as a heating element, via a mechanical or solid state relay. In *Diversion*, which features *Relay* and *Solid State* screens, the user programs set points—from -5.0 volts to 5.0 volts relative to the Absorb, Float and EQ voltages—to activate the *AUX MODE*. With wind or hydro generator applications, keep the Charge Controller's diversion voltage slightly above its Absorb and Float voltages for efficient functioning.

This is primarily an off-grid function. Pressing the **<MODE>** soft key displays *Auto* and *On* modes in addition to *Off*. Pressing the **<SET>** soft key displays the *Diversion: Relay TIME* and *VOLT* screen.

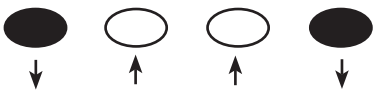
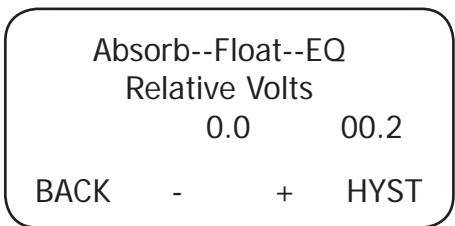
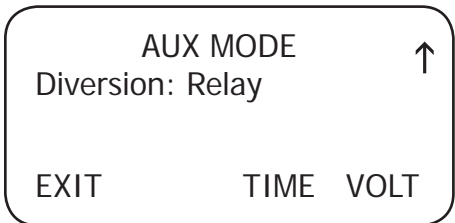
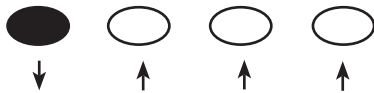
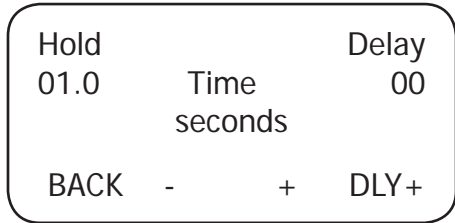
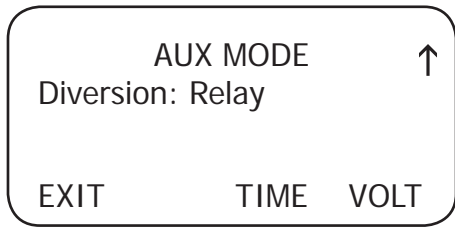

Press the **<TIME>** soft key to advance to the *Time* screen which allows the user to adjust the minimum time the *AUX MODE* is active after the battery voltage falls below the Hysteresis voltage.

Hold Time shows how long the *AUX MODE* stays active after the battery voltage has fallen below the HYST (Hysteresis) set point. The user can adjust the *Hold Time* from 0.1 to 25 seconds.

The *Delay Time* shows how long the battery voltage must be above the *Relative Volts* before the *AUX MODE* is activated. It can be adjusted from 0 to 24 seconds, *but is rarely required*. Pressing the **<BACK>** soft key returns to the *AUX MODE Diversion: Relay TIME* and *VOLT* screen.

Press the **<VOLT>** soft key.

Use this screen to establish the set points for starting and ending the *AUX MODE* relative to the *Absorb, Float, and EQ* voltages. The **<->** and **<+>** soft keys set the *Diversion* set points. The **<HYST>** (Hysteresis) set point establishes when the *AUX MODE* becomes inactive after the battery voltage falls below the *Relative Volts* voltage minus the HYST value. After establishing these values, press the **<BACK>** soft key to return to the *Diversion: Relay TIME* and *VOLT* screen.



Press the **<EXIT>** soft key.

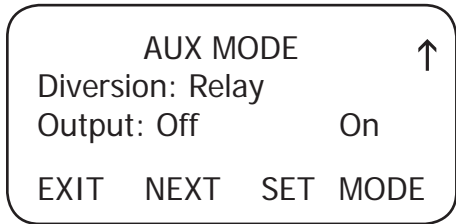

If a *Solid State Relay* is used, press the **<NEXT>** soft key to access the *Diversión Solid St* screen.

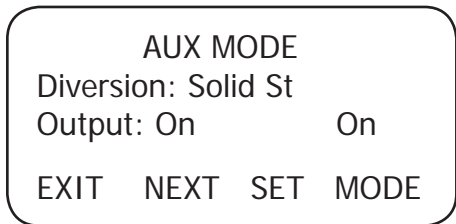

To adjust the time and voltage when a solid state relay is used, press the **<TIME>** and **<VOLT>** soft keys respectively and follow the same steps as for the *Diversión:Relay* screen. Note the values are displayed as percentages when a solid state relay is used. When any adjustments are completed, return to the *Diversión: Solid St* screen and press the **<NEXT>** soft key to view the *AUX MODE Low Batt Disconnect* screen.



Example of Diversion

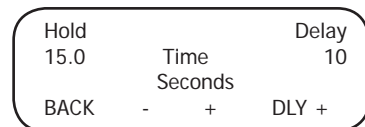
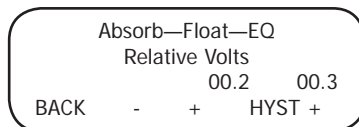
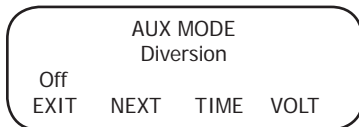

Each recharging state—*Absorb*, *Float*, or *EQ*—has a recharging voltage set point. The *Diversión* AUX MODE can be active (*On*) when the battery voltage is raised above one of these set points for a certain amount of time or inactive (*Off*) when it falls below. The user can determine these voltages and times. In the example above, when the RE source (wind or hydro) raises the battery voltage 00.2v above the chosen set point for a *Delay* time of 10 seconds—the AUX Output will be active. When the battery voltage falls 00.3v below the HYST voltage set point for a Hold time of 15 sec – the AUX Output will be inactive (*Off*). See Figure 5, next page, for Diversion Load and AUX Wiring Set-Up.

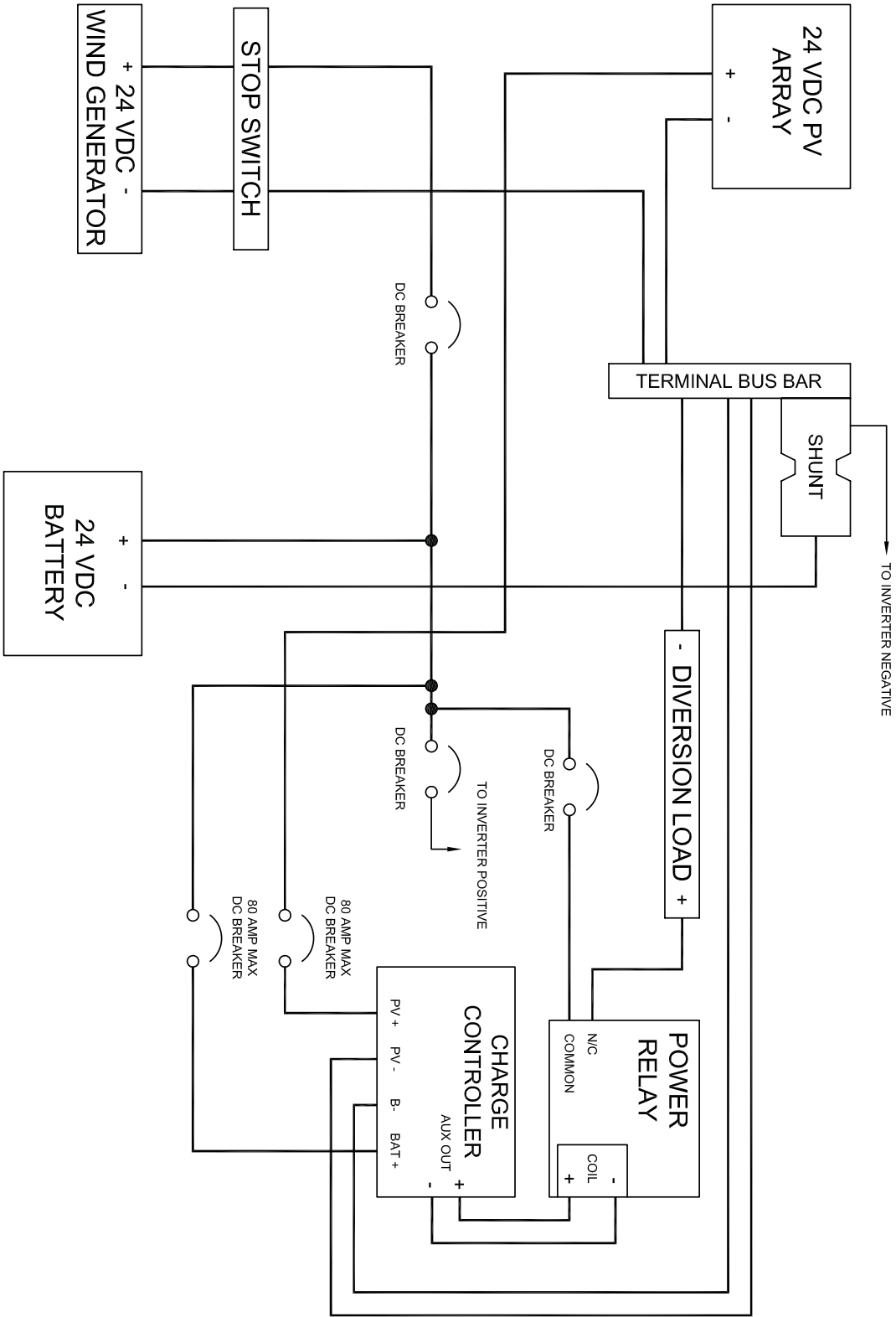
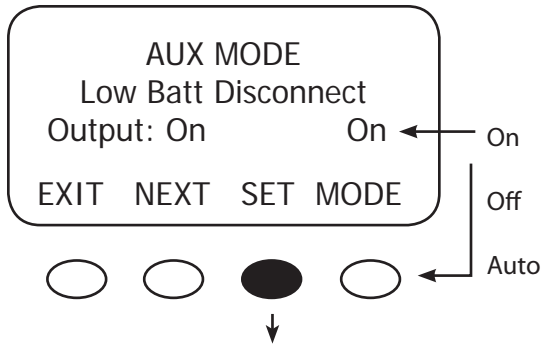
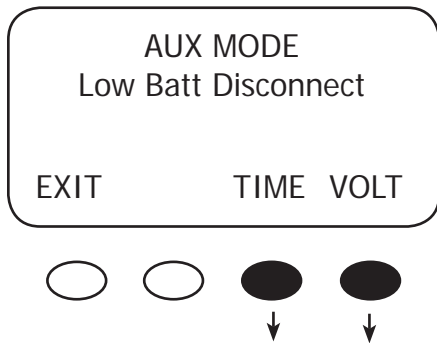

Figure 5 Diversion Load and AUX Wiring Set-Up Illustrated

LOW BATTERY DISCONNECT



When the battery voltage falls below the disconnect volts, the *AUX connected loads only* are disconnected; the *AUX connected loads only* are connected when the battery voltage rises above the reconnect volts. To adjust these set points, press the **<TIME>** and **<VOLT>** soft keys.



Press the **<TIME>** and **<VOLT>** soft keys to adjust the set points.

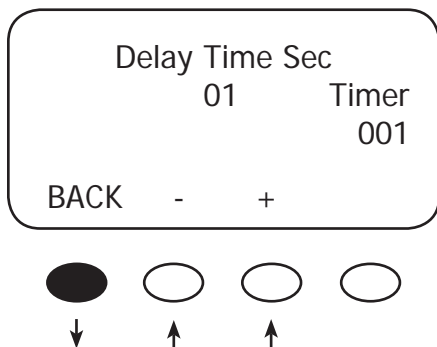

Press either the **<->** or **<+>** soft key to adjust the delay time. This is the time period the Charge Controller waits before either activating or deactivating the *AUX MODE* when either the disconnect or reconnect voltages are reached. When the low voltage occurs, the timer shows the seconds remaining before disconnecting. When the reconnect voltage is reached, the timer shows the user-determined time before connecting. Press the **<BACK>** soft key to return to the *Low Batt Disconnect* screen.

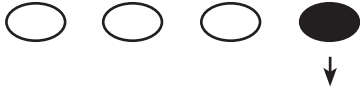

In the *Low Batt Disconnect* screen, press the **<VOLT>** soft key to adjust the battery voltage disconnects set point.

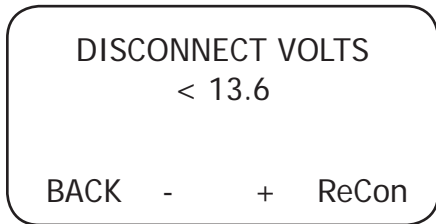

Press either the **<->** or the **<+>** soft key to adjust the disconnect voltage. Press the **<ReCon>** soft key to open the *RE-CONNECT VOLTS* screen.

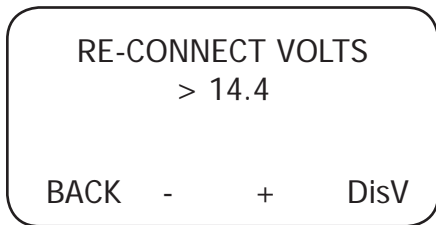

Press either the **<->** or the **<+>** soft key to adjust the *RE-CONNECT VOLTS* value. The AUX Output activates when the voltage goes above this setting after the timer has counted back to zero. Press the **<BACK>** soft key to return to the *Low Batt Disconnect* screen. Press the **<DisV>** soft key to return to the *Disconnect Volts* screen.



Press the **<EXIT>** soft key.

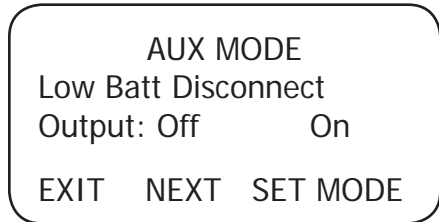
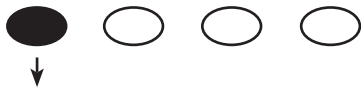

Press the **<NEXT>** soft key to view the *Remote* screen.



REMOTE

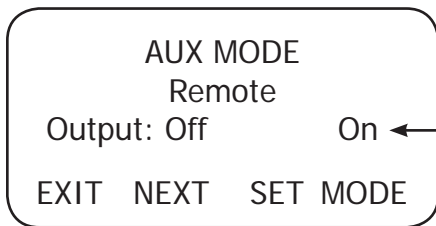

In Remote *AUX MODE*, the OutBack MATE can control the Charge Controller's *AUX MODE*. Press the **<EXIT>** soft key *twice* to return to the *MAIN* Menu screen.

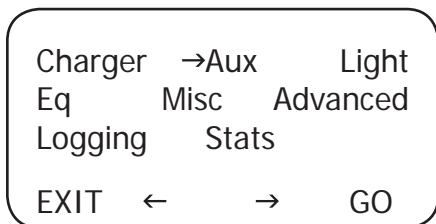

Press the **<=>** soft key to move the "→" to the *Light* option. When the → is in front of *Light*, press the **<GO>** soft key.

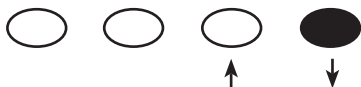

10. Backlight

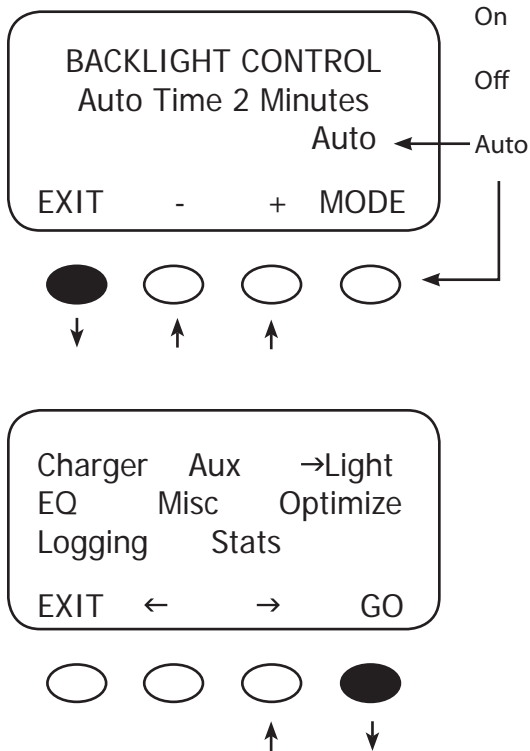

Auto (default) leaves backlight and soft keys on for up to nine minutes whenever any soft key is pressed (pressing any soft key when the LCD is *not* lighted does not change any settings). Minutes are adjustable using the <-> and <+> soft keys.

On or *Off* states are also available.

Press the <EXIT> soft key twice to return to the *MAIN* Menu screen

Press the <-> soft key to move the "→" to the *EQ* option. When the → is to the left of *EQ*, press the <GO> soft key.

11. EQ—Battery Equalize

The intent of an equalization charge is to bring all battery cells to an equal voltage. Sealed batteries should not be equalized unless specifically instructed by the manufacturer. Shut off or minimize all loads on the battery. When equalizing, be sure the EQ voltage will not damage any still energized DC load. If possible, ensure the EQ cycle starts and stops the same day it is initiated or unnecessary battery gassing will occur.

- Occasional equalization extends the life of flooded electrolyte batteries.
- Proceed with caution! A vent fan is recommended in enclosed spaces.
- The Charge Controller allows the user to set voltages and times of equalization process.
- Both manual and auto modes are available.
- EQ voltage is *not* battery temperature compensated.
- *Always check the electrolyte level in the batteries before and after equalizing.*

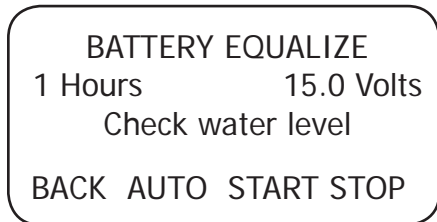
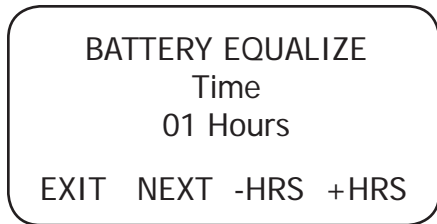
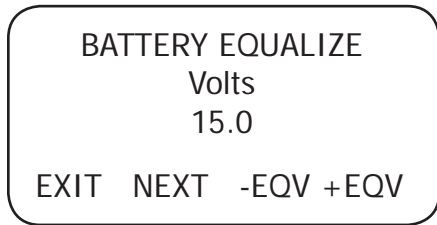

Press either the **<-EQV>** or **<+EQV >** soft key to change the EQ voltage, following your battery manufacturer's recommendations. Note that the factory default EQ voltage is set low, the same as the factory default Absorb voltage. Press the **<NEXT>** soft key to view the *BATTERY EQUALIZE Time* screen.

Press either the **<-HRS>** or **<+HRS>** soft key to set the desired equalization time, up to a seven hour maximum, always following your battery manufacturer's recommendations. Press the **<NEXT>** soft key to view the battery equalization start screen.

Manual Mode (default mode)

- Press the **<START>** soft key to manually begin an equalization cycle. To stop the cycle, press the **<STOP>** soft key.
- *EQ-MPPT* display indicates the Charge Controller is trying to reach the target equalize set point.
- Equalize time *EQ 0:00* in Hours:Minutes displays after the equalize set point is reached.
- The incomplete equalization cycle continues into the next day unless the Charge Controller is powered off or manually stopped. The remaining EQ time can be viewed in the *Stats* menu.
- EQ cycle terminates when EQ time period is reached.
- After equalizing, an *EQ DONE* message displayed and a *Float* cycle begins. This message remains displayed until a soft key is pressed.

Press the **<AUTO>** soft key to view the auto equalization screen.

AUTO MODE

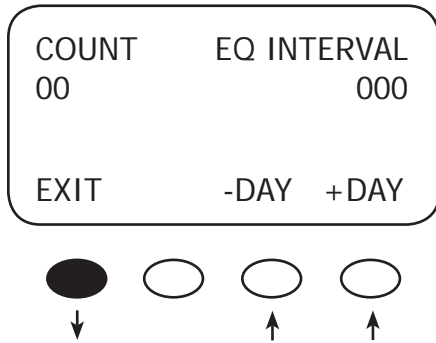

Use the **<-DAY>** and **<+DAY>** soft keys to preset the interval day to initiate an automatic equalization cycle. The *EQ INTERVAL* displays the number of days in the interval between cycles and *COUNT* displays how many days of the interval have passed. To view the *MAIN EQ* screens, press the **<EXIT>** soft key.

NOTE:

- *Auto Mode* initiates when a preset interval day (1-250 days) is reached.
- The default equalize interval (EQ INTERVAL) setting is 000 day leaving the auto eq disabled.
- EQ-MPPT display indicates the Charge Controller is trying to reach the target equalize set point.
- The equalize time *EQ 0:00* in Hours:Minutes displays after the equalize set point is reached.
- An incomplete equalization cycle continues into the next day unless the Charge Controller is powered off or manually stopped. The remaining *EQ* time can be viewed in the Stats Menu.
- The *COUNT* value will be cleared to 000 when an *EQ* is started, manually stopped, or Charge Controller has been powered off.
- After recharging, an *EQ DONE* message displays and a *Float* cycle begins. EQ DONE is displayed until (1) any soft key is pressed or (2) a new day occurs for systems using an OutBack MATE.

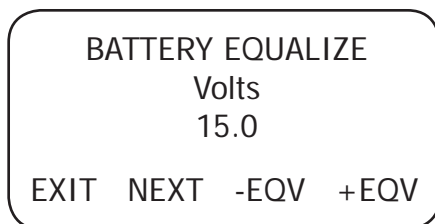

Press the first soft key twice to return to the *MAIN* Menu.

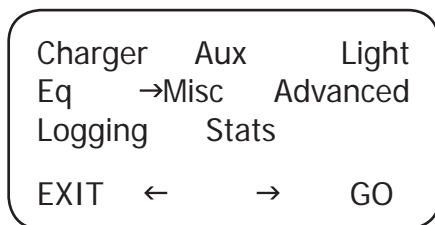

Press the **<→>** soft key until the **→** is in front of **Misc**. Press the **<GO>** soft key to view the *Misc* screen.

12. MISC—Miscellaneous

The MISCELLANEOUS screens display extra settings and technical information, some of which is useful for OutBack Power Systems Technical Services.

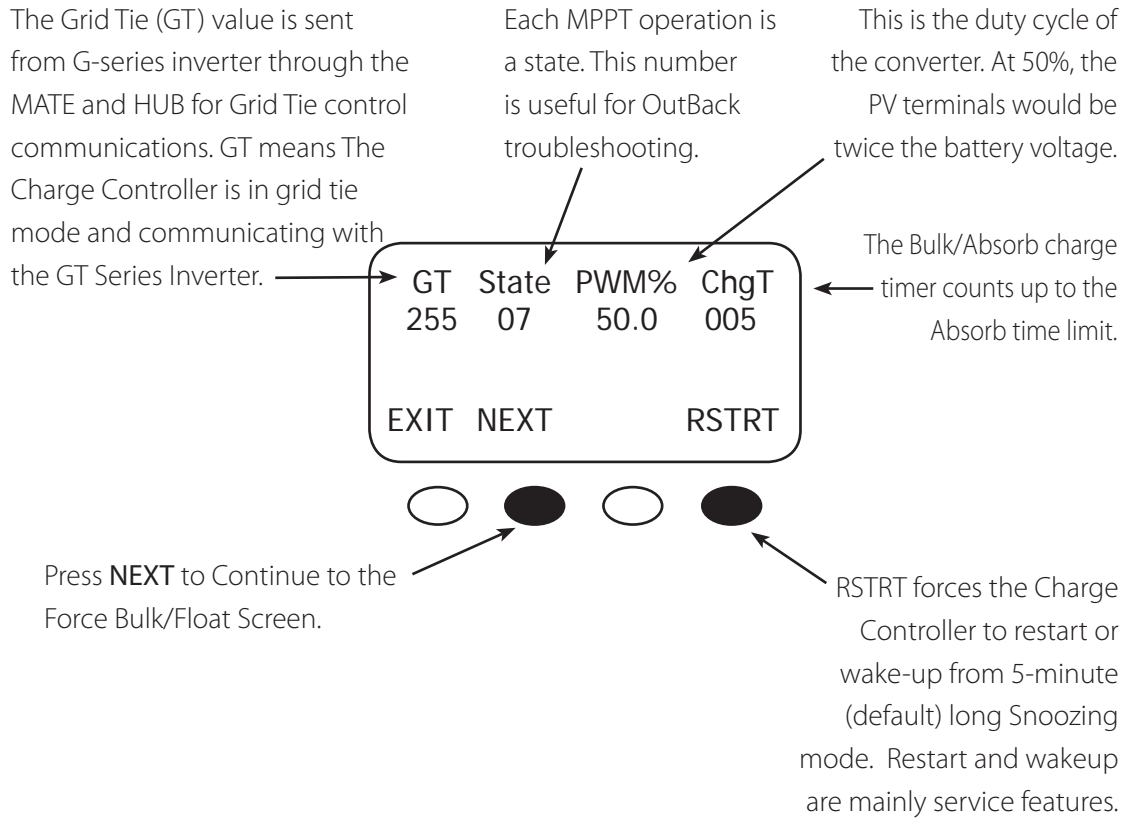

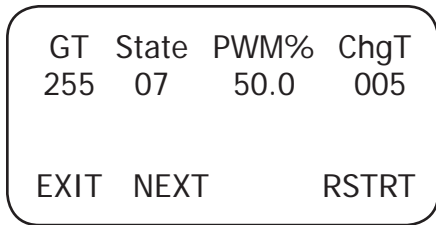

Press the **<NEXT>** soft key to view the *FORCE FLOAT*, or *BULK* screen.

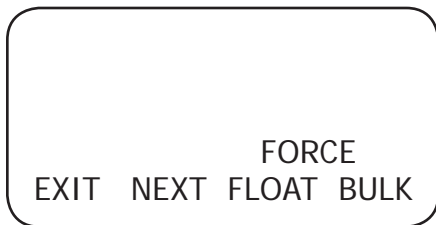

Pressing the **<FLOAT>** or **<BULK>** soft key forces the Charge Controller to that specific recharging cycle and returns to the *STATUS* screen. Forcing a *FLOAT* or *BULK* recharge will end an *EQ* cycle. Press the **<NEXT>** soft key to view the third *MISCELLANEOUS* screen.

- Force FLOAT = float cycle
- Force BULK = bulk cycle

This is the assigned number representing the temperature of the internal components to control the cooling fan. The lower the number, the higher the temperature. 25° C is approximately a value of 525.

Btmp is a battery temperature sensor reference value used to compensate the charging voltage.

This is an arbitrary number between 0 and 255 and is not the actual temperature. An 'X' next to this value indicates a Global external RTS is being used (system with a HUB and MATE).

The target voltage the controller is trying to reach.

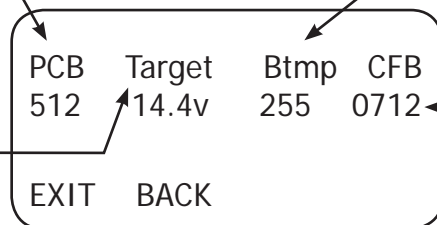

The output value of the internal current sensor is used to calculate output amps, watts, and track the Maximum Power Point of the array.



Press the **<EXIT>** soft key twice to return to the MAIN MENU.

13. Advanced

The ADVANCED MENU allows fine-tuning of the Charge Controller operations including *Snooze* periods and Maximum Power Point limits. In order of appearance, the following modes occur in the ADVANCED Menu selections:

- *Snooze Mode* • *Wakeup* • *MPPT Mode* • *Park Mpp* • *Mpp Range Limit % Voc*
- *Absorb Time* • *Rebulk Voltage* • *Vbatt Calibration* • *RTS Compensation* • *Auto Restart*
- *Aux Polarity* • *Reset to Defaults?*

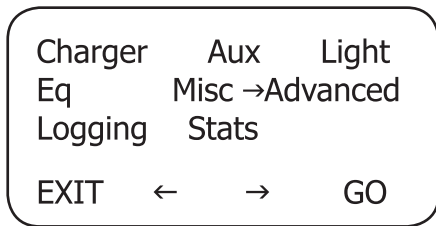

From the MAIN Menu, choose *Advanced* and press the **<GO>** soft key.

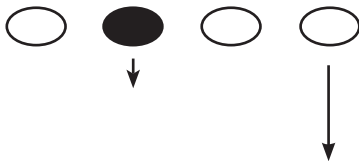
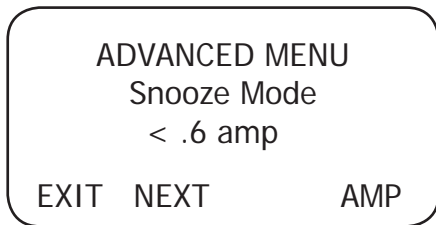

Snoozing occurs if the recharging current does not reach the user-selected cutoff current set point as shown in this screen. Press the **<AMP>** soft key to adjust the amp setting. Press the **<NEXT>** soft key for the *Wakeup Mode* screen.

- Amp Values
- 0.2
 - 0.4
 - 0.6
 - 0.8
 - 1.0

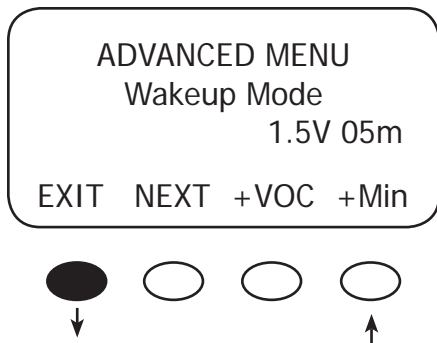

Wakeup Mode selects how often the Charge Controller does a “Wakeup” during “Snoozing” periods. Since environmental conditions impact the open circuit voltage (Voc) of an array, a user selectable Voc rise in value will allow the controller to “wakeup” sooner or later based on the last measured Voc value. A selectable delay time in minutes will also allow the controller to “Wakeup” sooner or later if the measured Voc did not meet the user selectable Voc rise in value. Before changing these values, monitor your system for a week or so using the factory defaults and then gradually adjust the set points. If they’re set too high, the Charge Controller might not wake up soon or often enough, which means a loss of power production. Note: +VOC ranges from 1.5V up to 9.5V. +MIN ranges from 5 up to 15 minutes. Press the **<NEXT>** soft key to go to the *MPPT Mode* screen.

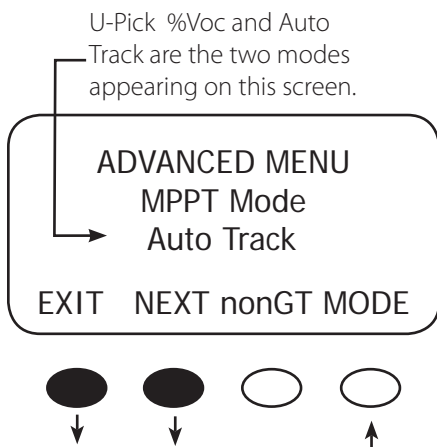

This screen allows the user to choose one of these modes:

- *Auto Track MPPT Mode* (the default and preferred mode) automatically tracks the PV upon wakeup and then tracks the MPP of the array. If the Auto Restart is set to 1 or 2, the Charge Controller awakes every 1.5 hours and does an initial tracking.
- *U-Pick % (Voc) MPPT mode* operates the PV voltage at a user-selected percentage of the Voc. This percentage is displayed in the *Park Mpp % Voc* screen along with the current output wattage. The wattage value changes as the user adjusts the Voc percentage, allowing the user to lock-in the most advantageous percentage value. *U-Pick %* acquires a new VOC value every 1.5 hours if Auto Restart is set to 1 or 2.

Press the **<MODE>** soft key to choose an MPPT mode. If you have an OutBack G-series inverter system with a HUB and MATE, press the **<nonGT>** soft key to activate the charge controller’s grid-tie mode.

Press the **<NEXT>** soft key to view the *Park Mpp* screen.

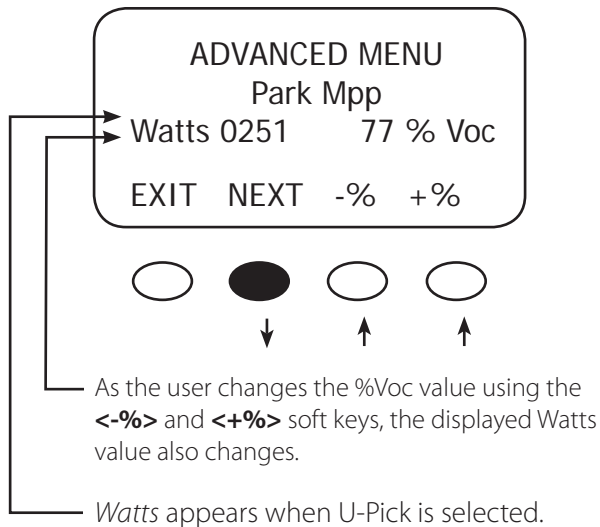
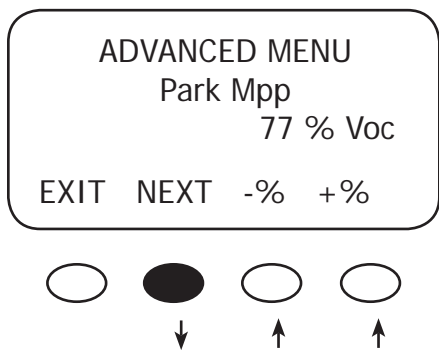

Press the **<NEXT>** soft key to view the *Park Mpp* screen.

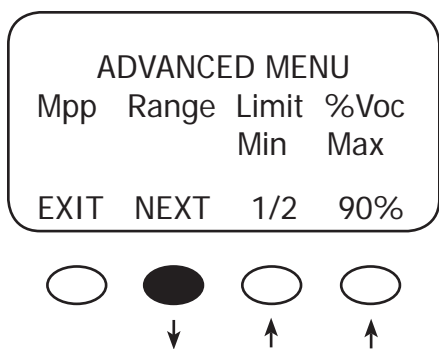

Use 1/2 value for high input arrays to speed up initial tracking.

U-Pick % (Voc) MPPT mode operates the PV voltage at a user-selected percentage of the VOC which is displayed in the *Park Mpp % Voc* screen. Press the **<NEXT>** soft key to view the *Mpp Range Limit %* screen.

The *Mpp Range Limit % Voc* adjusts the upper Mpp limit of the VOC. The default Charge Controller MPP voltage limit is set at 90% of the VOC and is normally left alone for an array. Setting *min* to 1/2 reduces the initial tracking time on a high input voltage array and also tracks one-half the VOC voltage.

The MPP adjustable Charge Controller limits are 80%, 85%, 90%, and 99% of the VOC. The *min* range limit setting may be set to *FULL* if something other than a PV array is connected to the input of the Charge Controller, such as a micro-hydro generator (see page 58), but the VOC cannot exceed 150 VDC at any time. Press the **<min>** or **<max>** soft key to adjust the MPP range limit. When done, press the **<NEXT>** soft key to view the *Absorb Time* screen.

14. Charging-Related Screens

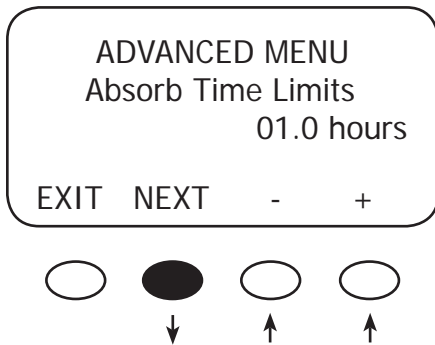

In the *Absorb Time Limits* screen, the user can set the duration the Charge Controller stays in the *Absorb* recharge cycle.

- *Absorb Time* is adjustable from 0 to 24 hours (consult your battery manufacturer's recommendations).
- A *Bulk* cycle starts each morning (see chart next page). The charge timer (*ChgT*) is preset to zero.
- The *ChgT* counts up to the Absorb Time Limit after the Absorb voltage is reached.
- If the system cannot maintain the Absorb voltage set point during the *Absorb* cycle, the timer will stop counting up.
- If the battery voltage is greater than or equal to 12.4V, 24.8V, 37.2V, 49.6V 62.0V and less than the absorb voltage, the *ChgT* timer does not change.
- If the battery voltage is less than 12.4 V, 24.8V, 37.2V, 49.6V or 62.0V, the *ChgT* timer counts down to zero in minutes—for every minute elapsed, one minute is subtracted from the timer.
- If the battery voltage is less than 12.0V, 24.0V, 36.0V, 48.0V or 60.0V, the *ChgT* timer counts down to zero at twice as fast—for every minute elapsed, two minutes is subtracted from the timer.
- If the battery voltage is less than 11.6V, 23.2V, 34.8V, 46.6V, or 58.0V, the *ChgT* timer counts to zero four times as fast—for every minute elapsed, four minutes is subtracted from the timer.
- When the *Absorb Time Limit* is reached, the Charge Controller goes into *Float* stage and may briefly display *Charged* then *Float*. When the battery voltage drops below the float voltage set point, the Charge Controller recharges to maintain this set point, employing the *F(Float)-MPPT* function.

To adjust the *Absorb Time* limit, press either the **< + >** or **< - >** soft key. When finished, press the **<NEXT>** soft key to view the next screen.

Charge Controller Multi-Stage Battery Charging

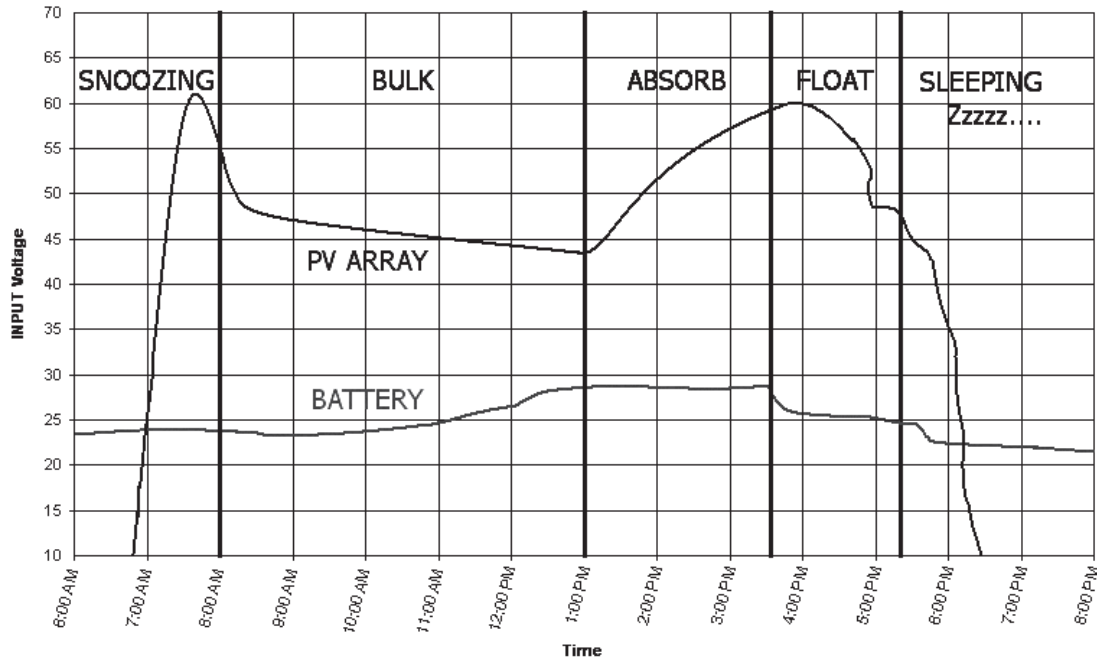
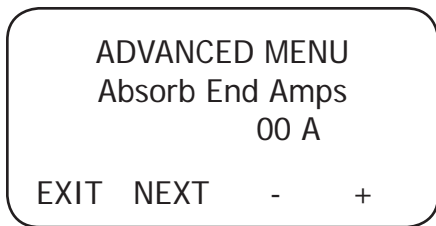
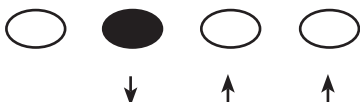
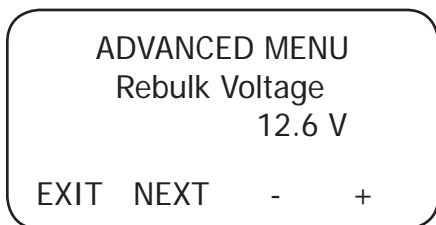

Figure 6 NOTE: In *BULK*, the Charge Controller will charge as long as necessary to complete the cycle, regardless of the timer's set points



An *Absorb* charge cycle normally ends when a battery voltage is maintained at the *Absorb* set point for the user-determined time period. Use the \leftarrow or $\leftarrow +$ soft keys to adjust the *Absorb End Amps* to an optimal value (the default value is 00). While the battery voltage is at or above the *Absorb* target and the *Absorb End Amps* value is reached for a time delay of 15 seconds, the Charge Controller will switch to the *Float* stage regardless of the charger time minutes as shown in the *Misc* menu under *ChgT*. The charger timer will be cleared. This is an optional set point and is used for few installations.

When finished with any adjustments, press the **<NEXT>** soft key to view the *Rebulk Voltage* screen.



In *Float*, if the battery voltage falls below the *Rebulk Voltage* set point for at least 90 seconds, the Charge Controller will automatically reinitiate a *Bulk* charge cycle. The default is set to 6 volts, a very low value that will disable this function. The *Rebulk Voltage* value can be adjusted by pressing the \leftarrow or $\leftarrow +$ soft keys. Press the **<NEXT>** soft key to view the *Vbatt Calibration* screen.

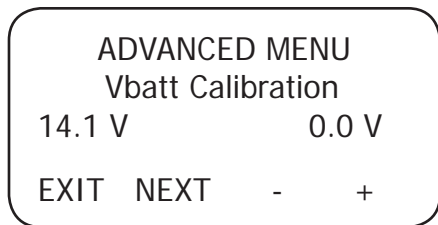

RTS Compensation*

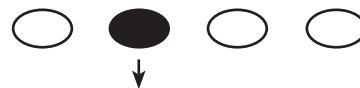
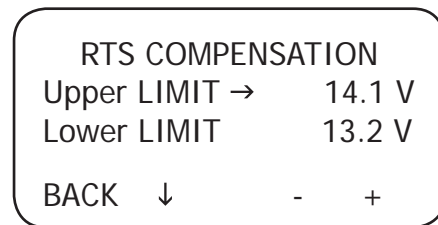
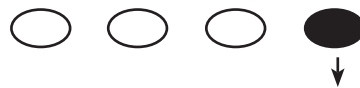
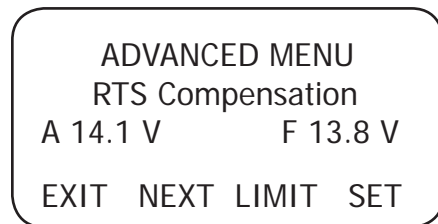
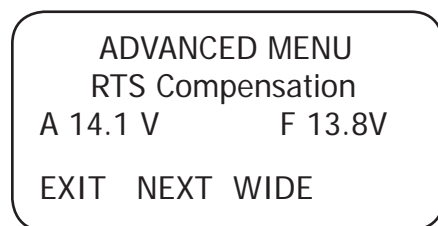

A quality calibrated voltmeter will provide even more accurate Charge Controller battery readings if an undesirable voltage drop occurs. When measuring battery voltage, ensure a good connection is made to the four wire lugs. Check the battery temperature compensation voltages if the voltages are much different than you expect from the charger setup *Absorb* and *Float* voltage settings. Use the **<->** and **<+>** soft keys to match the readings from the voltmeter (use of appropriate wire gauge will minimize voltage drop). When finished, press the **<NEXT>** soft key to view the *RTS Compensation* screen.

During cold weather, a battery often requires a higher recharging voltage. Lower quality inverters might not accommodate these higher voltages and can shut down during recharging, cutting off power to their loads. The Charge Controller allows the user to lower the compensated voltage in the Absorb cycle so these inverters will remain operating. Also, some batteries have an absolute voltage limit that should not be exceeded and the *WIDE/LIMIT* option allows the user to control this during recharging. *WIDE* allows the *RTS* full control over recharging; *LIMIT* sets the ceiling and floor voltages for the *RTS*.

During hot weather, the *LIMIT* feature set point assures recharging will continue at a high enough voltage rather than dropping too low in reaction to a higher ambient temperature. This assures the recharging voltage adequately charges, but should be monitored according to the battery manufacturer's recommendations.

The *RTS* default compensated voltages apply if the *WIDE/LIMIT* option is set to *WIDE*. To change these values, press the **<WIDE>** soft key to bring up the next screen which allows user-determined limits. Press the **<SET>** soft key to adjust these values.

Press the **\downarrow** soft key to choose the limit value you want to adjust. Press the **<->** and **<+>** soft keys to adjust the chosen value(s). When finished, press the **<BACK>** soft key to return to the *RTS Compensation* screen.

*Optional OutBack *RTS* **must** be installed

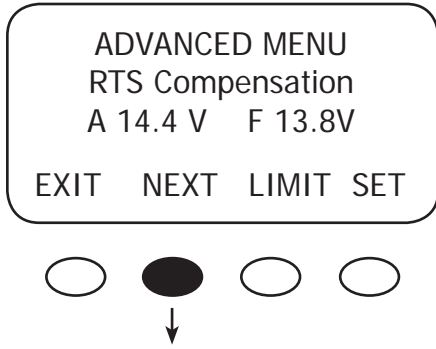

Press the **<NEXT>** soft key to view the *Auto Restart* screen.

AUTO RESTART

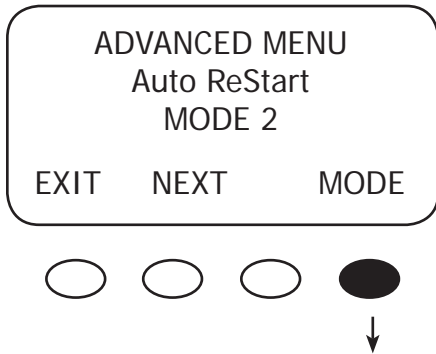

Pressing the fourth soft key selects among the three Charge Controller *Auto ReStart* modes: 0 (default), 1, and 2. *Auto ReStart* allows the Charge Controller to perform internal recalibrations.

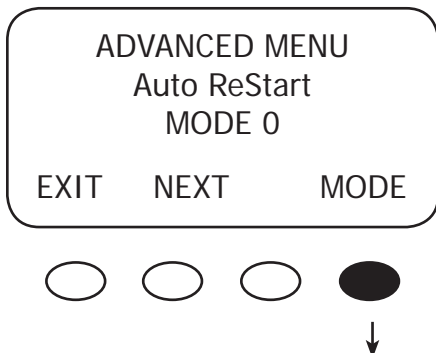

- *Mode 0*— *Auto ReStart* mode is disabled; the Charge Controller recharges continuously from an available source and never *Restarts*. *Mode 0* would be chosen to avoid spinning a microhydro generator every 1.5 hours.
- *Mode 1*—once every 1.5 hours, when the Charge Controller is in *Bulk*, it will briefly *Restart* and initiate a full panel tracking. This will not reset any counters or charging stages or statistics.
- *Mode 2*— *Auto ReStart* every 1.5 hours; in *Bulk*, *Absorb*, and *Float* modes, it will briefly *Restart* and initiate a full panel tracking. This will not reset any counters or charging stages or statistics.

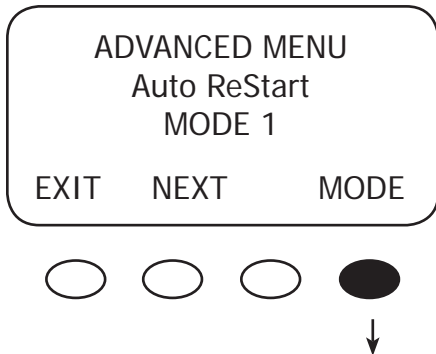

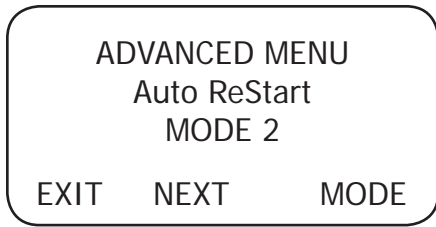

From the *Auto Restart MODE 2* screen, press the **<NEXT>** soft key to view the *Aux Polarity* screen.

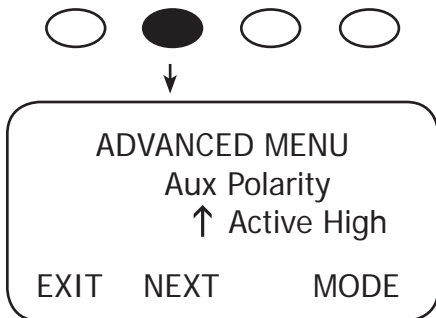

When the AUX function is ON, 12 volts is present at the AUX terminal; when it's OFF, 0 volts are present at the terminal. *Aux Polarity* allows the user to reverse the availability of this voltage for the *Night Light*, *PV Trigger*, or *Diversion Relay* functions. In *Active High*, the user establishes certain conditions for these functions. Pressing the **<MODE>** soft key brings up the *Active Low* screen which allows the user to reverse these conditions.

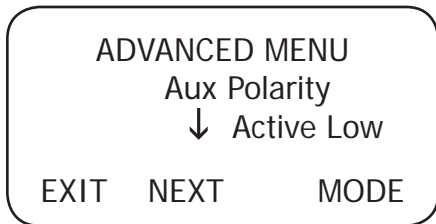
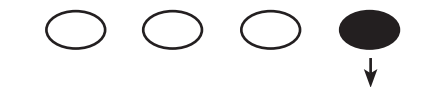

In the *Active Low* zero voltage will be available for a function that in *Active High* would normally have voltage. When one of the three functions— *Night Light*, *PV Trigger*, or *Diversion Relay*—has been chosen as the AUX function, an arrow in the right hand corner of the screen will reflect the *Aux Polarity* state. An arrow pointing up means *Active High* while an arrow pointing down means *Active Low*. Press the **<NEXT>** soft key to view the *Reset to Defaults?* screen.

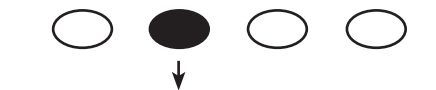

EXAMPLE

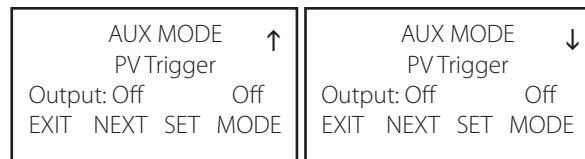

PV Trigger Active High

PV Trigger Active Low

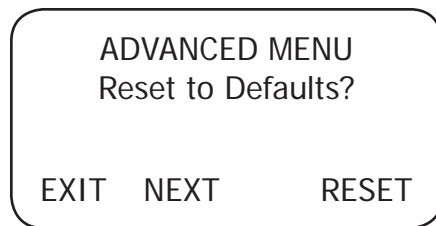

In this screen, a user can press the **<RESET>** soft key to return the Charge Controller to the factory default settings. (If you do not need to reset, press the **<EXIT>** soft key to return to the *STATUS* screen.)

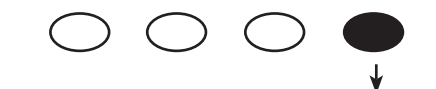

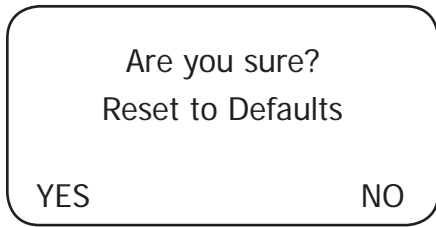

Pressing the **<YES>** soft key brings up a *Reset to Defaults* screen momentarily before returning to the *Reset to Defaults?* screen

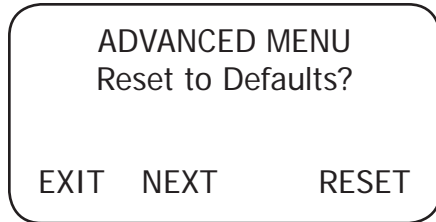

Press the **<EXIT>** key twice to return to the MAIN Menu screen.

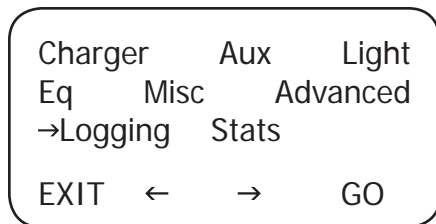

From the *MAIN* Menu, press the **<->** soft key to move the arrow next to the *Logging* function and then press the **<GO>** soft key. This leads to the *End of the Day Summary* screen, which is a log of the daily statistics and can be viewed at any time.



15. Logging

Today 0000Ah 00.0 KWH
 011Vp 00.0Ap 0.00kWp
 MAX 14.7V ABS 01:00
 MIN 14.6V FLT 00:00



CLEAR LOG

BACK TOTL DAILY



Are you sure?

NO YES



Today 0000Ah 00.0 KWH
 011Vp 00.0Ap 0.00kWp
 MAX 14.7V ABS 01:00
 MIN 14.6V FLT 00:00



A user can clear either the daily or accumulated statistics of the Charge Controller by pressing the second button from the left in this screen. This will bring up the *CLEAR LOG* screen.

The *CLEAR LOG* screen offers the option of clearing up to 128 days of accumulated statistics or the total in the secondary *STATS* screen (page 56). Press and hold either the **<TOTL>** (total) or **<DAILY >**key to clear those specific statistics.

The *Are you sure?* screen appears. Pressing the **<YES>** soft key returns to the *CLEAR LOG* screen; pressing the **<NO>** soft key returns to the *Logging* screen.

Pressing the third and fourth soft keys changes the displayed day's statistics, by moving either forward or backward within the 128 days of available statistics that are viewable.

NOTE: If two or more Charge Controllers are used in the same system and are started up or cleared on different days, their numeric dates will not be the same. This can lead to some misunderstandings when looking back and comparing data between the two or more units. A user looking back at day 12 on both units would find very different results.

16. Stats

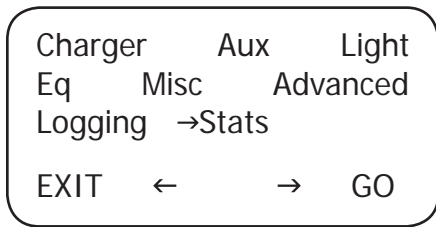

From the MAIN Menu, press the <=> soft key to move the arrow next to the Stats function and then press the <GO> soft key



The *STATS* screen displays additional voltage and time information.

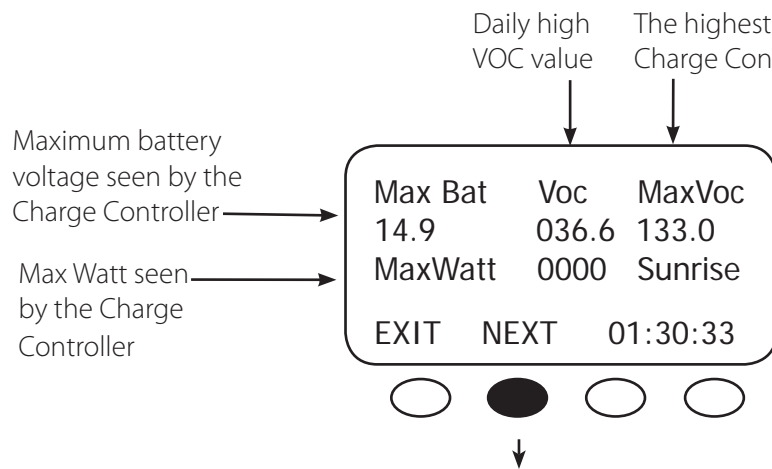

In a stand alone Charge Controller—one that is not connected to a MATE— Sunrise shows how long ago the Charge Controller woke up for the first time each day and when the daily and total logged values were updated and cleared from the STATUS screen. If the Charge Controller is connected to a MATE, the logging occurs at midnight.

Press the <NEXT> soft to view the second *STATS* screen.

Secondary STATS screen

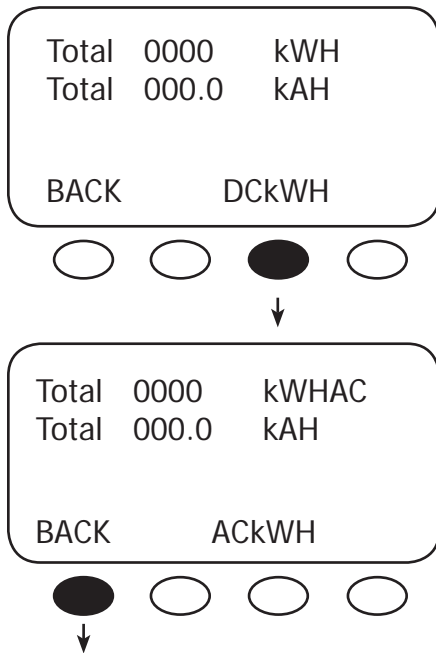

The *Secondary Stats* screen shows the total accumulated DC and AC kilowatt hours and kiloamp hours of the Charge Controller.

Pressing the **<DCkWH>** soft key switches the screen between DC kilowatt hours and AC kilowatt hours

- *DCkWH* shows the DC kilowatthours and should be used in a non-grid-tied system
- *ACkWH* is used with a grid-tied system. This measure is based on a 90% inverter efficiency (1 kWh DC= 0.9 kWh AC)

Pressing the first soft key three times returns to the *MAIN* Menu screen.

17. Micro-Hydro and Fuel Cell Applications

The Charge Controller is designed to work with solar arrays. Although it will work with micro-hydro turbines and fuel cell, OutBack Power Systems can only offer limited technical support for these applications because there is too much variance in micro-hydro and fuel cell generator specifications. When used for micro-hydro or fuel cell applications, the Charge Controller warranty will be honored only if the manufacturer and turbine model have been approved by OutBack Power Systems. Please check with one of the following manufacturers or OutBack Power Systems before employing the Charge Controller with these applications:

- Harris Hydroelectric
(831) 425-7652
www.harrishydro.com
- Alternative Power & Machine
(541) 476-8916
www.apmhydro.com
- Energy System & Design
(506) 433-3151
www.microhydropower.com

The Charge Controller is not compatible with wind turbine applications and OutBack cannot warranty its use in these applications.

MICRO-HYDRO AND FUEL CELL SYSTEMS PERFORMANCE OPTIMIZATION

Micro-hydro and fuel cell systems are different than PV systems, whose VOC output is more subject to change due to weather and time of day. A PV system normally finds its Maximum Power Point voltage between 50-90% of its VOC. A micro-hydro or fuel cell system's MPP voltage can be outside of this range.

The Charge Controller allows a user to experiment and find more appropriate set points to best capture the MPP voltage using *U-Pick* mode. Otherwise, *Auto Track* begins tracking the VOC and works its way down until the optimum percentage of input voltage yields the MPP voltage. If *U-Pick % Voc* is chosen, the MPP is calculated by whatever value is found in *Park Mpp*, even if it's not the optimal value for determining the MPP voltage. For this reason, OutBack normally suggests leaving the system in *Auto Sweep* mode.

18. Advanced Menu (Micro-Hydro and Fuel Cell Applications)

Mpp Range Limit % (Auto Track Mode only)

The Charge Controller searches for the MPP voltage by tracking the input voltage up to one half (default) of the Voc, which is based on values appropriate for a solar array. Micro-hydro and fuel cell systems can require a broader range, normally on the lower end. Adjusting the lower limit, expressed as *1/2* on the display screen, for *FULL* allows the Charge Controller to track the input voltage close to the battery voltage instead of 1/2 (or 50%) of the Voc.

This adjustment only affects the initial tracking at the beginning of the day and any subsequent trackings caused by Auto-Restart or any forced restart of the Charge Controller.

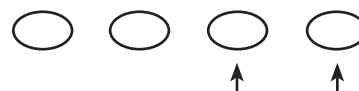
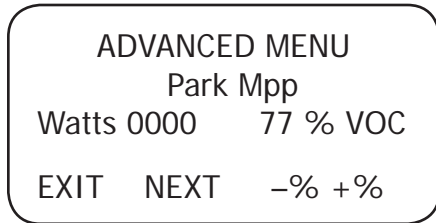
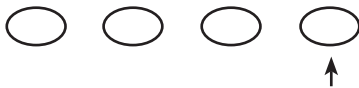
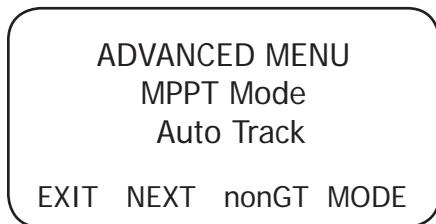
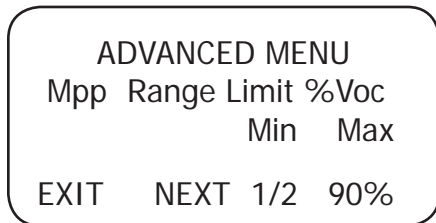
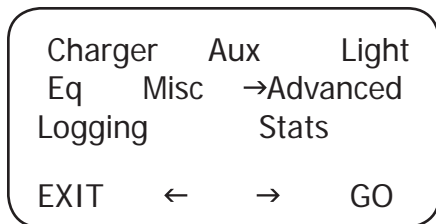

To adjust the Lower Mpp Range Limit:

From the *MAIN* Menu, with the arrow in front of *Advanced*, press the **<GO>** soft key.

In the *ADVANCED MENU* screen, press the **<NEXT>** soft key until the *Mpp Range Limit % Voc* screen appears. Press the **<1/2>** soft key until *FULL* appears. When finished, press the **<NEXT>** soft key until the *MPPT Mode* screen appears.

To pick between *Auto Track* or *U-Pick % MPPT Mode* and determine the Charge Controller's operating Voc percentage, press the **<MODE>** soft key to interchange between the two modes. Re-entering the password might be required. After choosing a mode, press the **<NEXT>** soft key in the *ADVANCED MENU* to view the *Park Mpp* screen (only applicable for *U-Pick* mode).

Press the **<-VOC>** or **<+VOC>** soft key to select one of the percentage values; *U-Pick* always uses the *Park Mpp* value.

19. Abbreviated Menu Map

Much of the Charge Controller activity takes place around the *MAIN* screen. From this screen, the user can access other screens to both observe system activity and make adjustments to certain critical functions.

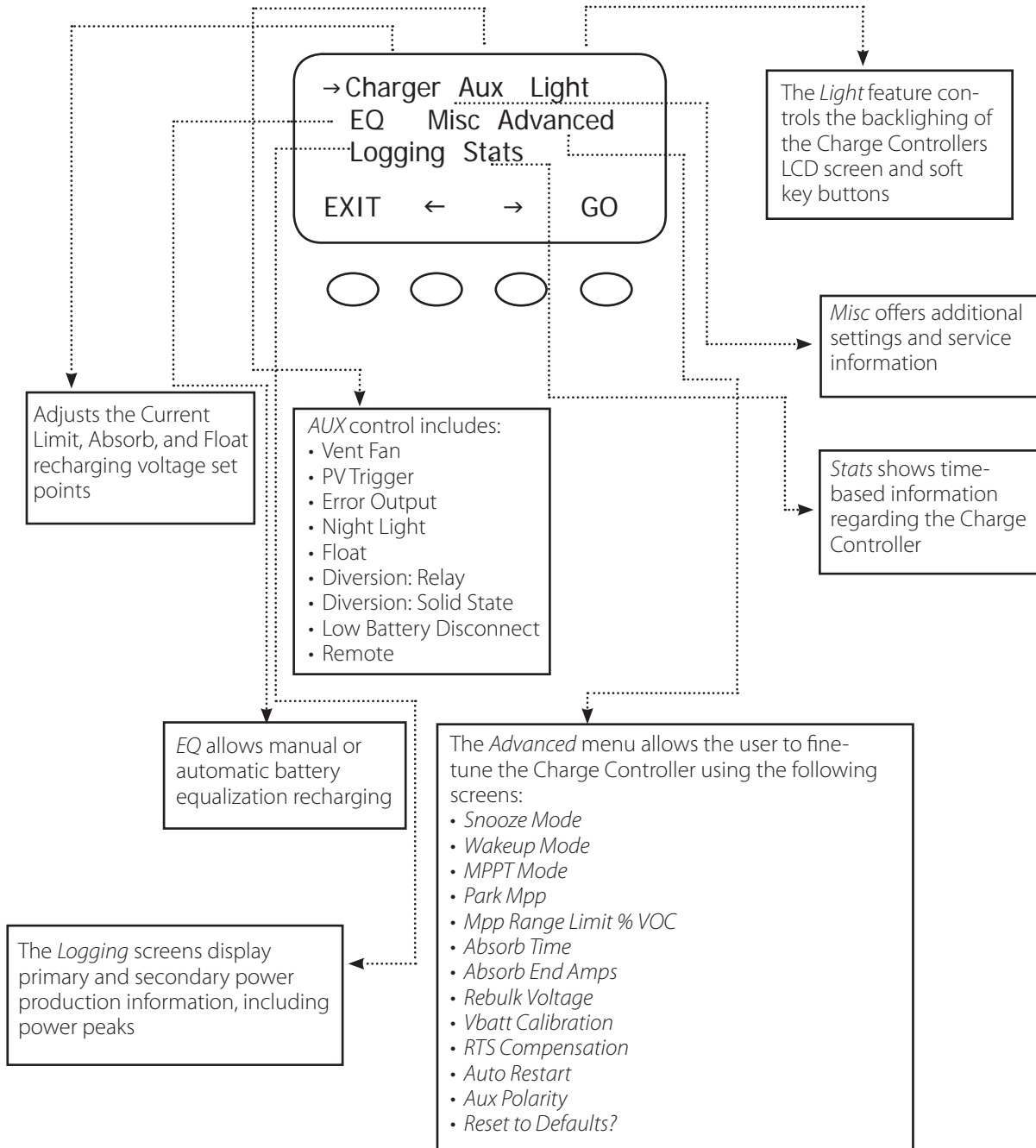

20. Application Notes

OutBack Power System GTFX/GVFX Grid-tie settings

In a GTFX/GVFX Series Inverter/Charger, Charge Controller, HUB, and MATE installation set the Charge Controller to GT mode in the ADVANCED MENU. GT mode allows the GTFX/GVFX to manage the Charge Controller float setting ensuring the Charge Controller is always keeping the battery above the sell voltage of the GTFX/GVFX.

Grid-tie applications (non-OutBack inverter/chargers)

When selling electricity back to the grid, keep the inverter Sell/Float voltage below the Charge Controller float voltage. Appropriate values: 0.5 Volts difference for 24V battery system or 1.0 volt difference for 48V battery systems.

Positive grounded systems

Telcom applications frequently require a positive grounded system. The Charge Controller switches the POSITIVE PV and battery leads. Keep these separate. If code allows, ground ONLY the battery positive lead in this case. Do not connect the Charge Controller's battery plus to the PV plus input while the Charge Controller is running. The OutBack HUB cannot be used in a positive grounded system.

21. Charge Controller EFFICIENCY vs. INPUT POWER GRAPH

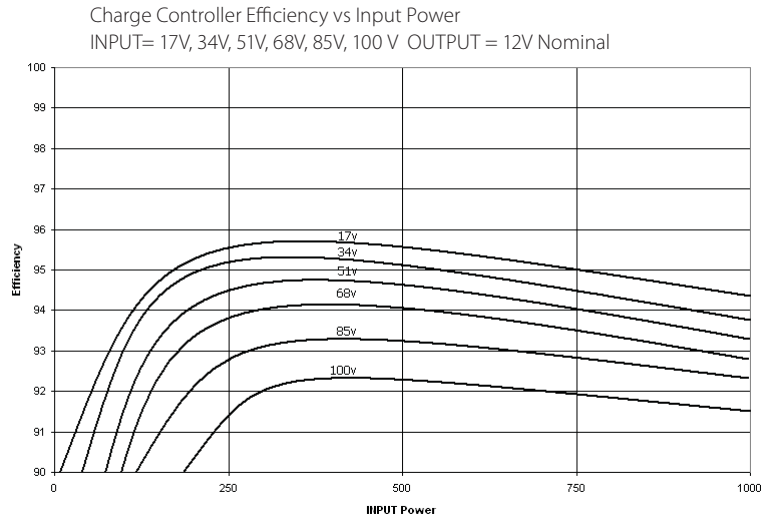

Figure 7 12V Battery System Efficiency Curve

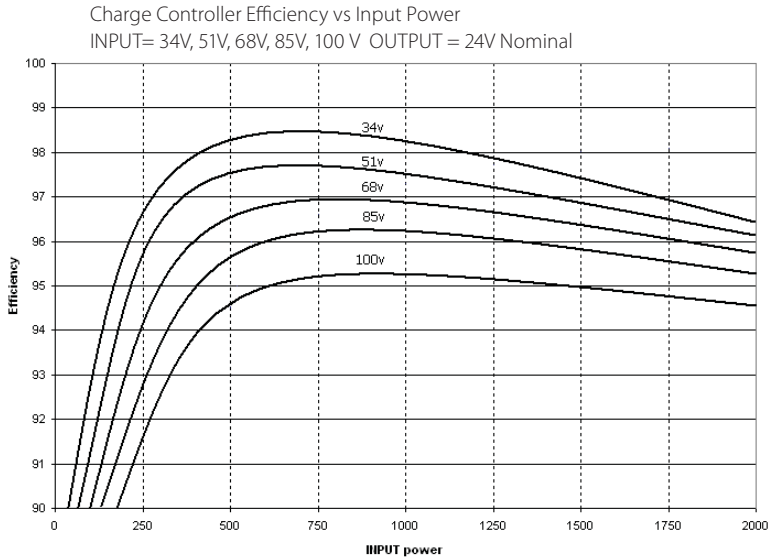

Figure 8 24V Battery System Efficiency Curve

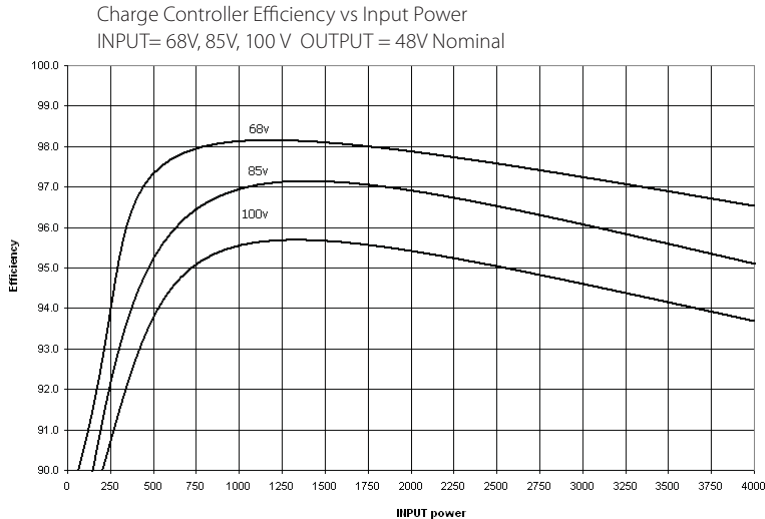

Figure 9 48V Battery System Efficiency Curve

22. Understanding the Various Operational Modes

The Charge Controller modes of operation will change occasionally during the day based on the PV array output and the battery system state of charge. The Charge Controller operating modes are displayed at the bottom right hand corner of the STATUS screen.

Absorbing The Charge Controller is in the Absorb (constant voltage) charge stage, regulating the battery voltage at the Absorb voltage set point (modified by battery temperature compensation if installed). During this cycle, the *ChgT* counter in the Misc menu is counting up towards the user defined *Absorb Time Limit*. If the system cannot regulate the battery voltage at the *Absorb* voltage set point, then the Charge Controller reverts back to the *Bulk* charge stage, display *MPPT Bulk*, and the *ChgT* counter may start counting down towards zero minutes or until the *Absorb* target is met. See page 49 for more information.

AutoStart (Auto Re-Start) Mode 1—Once every 1.5 hours in Bulk cycle and in Mode 2, once every 1.5 hours in the *Bulk*, *Absorb* and *Float* recharging modes, the Charge Controller will start over from sleeping and re-track (full track) and re-calibrate the current sensor. Mode 0 is disabled completely. (See *Stats* menu). Note: If enabled, *AutoStart* also occurs during the *MPPT EQ* cycle.

BatTmpErr The battery temperature sensor is shorted or damaged. The charging voltage will not be temperature compensated and the cooling fan will continuously operate.

BatTooHot The battery temperature sensor has detected a battery temperature of over 50°C. The Charge Controller will stop charging the battery and wait for the battery to cool below 50°C.

Charged There is an external DC source other than solar keeping the battery above the *Float* voltage set point-- the Charge Controller will stop charging. The display may also appear when the charge cycle is transitioning from *Absorbing* (upper target voltage) to *Floating* (lower target voltage).

EQ 0:00 This is the time elapsed in hours and minutes since the *Equalization* voltage set point was met. If the *EQ* voltage set point is not maintained, the controller will revert back – the EQ timer will pause until the batteries are regulated at the *EQ* voltage set point again. The paused time can be viewed in the *Stats* menu.

EQ Done Once the set *EQ* time (between 1 and 7 hours) has successfully completed, *EQ Done* will be displayed either until a button is pressed, or the next morning's wakeup. The Charge Controller will transition to *Float* cycle at the end of the completed *EQ* cycle.

EX-Absorb There is an external DC source other than solar keeping the battery above the *Absorb* voltage set point. The Charge Controller will stop charging.

Floating The Charge Controller is in the Float (constant voltage) charge stage and is regulating the battery at the *Float* voltage set point (modified by battery temperature compensation, if installed). If the system cannot maintain the *Float* voltage set point, (e.g. AC and/or DC loads are on), the Charge Controller will employ the *MPPT* function, display *MPPT Float*, and try its best to regulate the batteries to the *Float* voltage set point.

GT Mode In a system with an OutBack FX Grid-Tie Series Inverter(s), HUB *and* MATE, the Charge Controller will display *GT Mode* if and only if the inverter is in *Sell* mode *and* the Charge Controller is in *Bulk (MPPT BULK)* or *Float (MPPT FLOAT)* cycle. This is also a good indicator for establishing proper Grid-Tie mode communication between the FX G-Series Inverter(s) and Charge Controller. *GT* must be selected in the *MPPT Mode Advanced* menu in order to be viewed.

High VOC This indicates the PV array's open circuit voltage is too high for the controller to safely operate. This should only occur with systems using 72 VDC nominal PV arrays in very cold temperatures (below 5° F / -15° C). The controller will automatically restart operation once the PV array's open circuit voltage falls to a safe level (145 VDC or lower). The amount of time required before starting operation is dependent on the module type, ambient temperature, and the amount of sunlight directly on the PV array. Normally, the controller starts in the morning within a few minutes of the PV array being in direct sunlight.

Low Light / Snoozing During the initial tracking (*see Wakeup and Tracking*), if it is determined to be too late (or too early) in the day, the Charge Controller will display *Low Light* for a few seconds and then display *Snoozing* for 5 minutes (default). This reduces energy usage and unnecessary powering of the Charge Controller. This message is also displayed in extremely cloudy weather.

MPPT Bulk The Charge Controller is in *Maximum Power Point Tracking* mode trying to regulate the battery voltage towards the *Absorb* voltage set point. If the Charge Controller transitioned from *Absorbing* to *MPPT Bulk*, the *Charge Timer (ChgT)* counter may start counting down towards zero minutes or until the *Absorb* target is met. See page 49 for more information.

MPPT Float The Charge Controller is in *Maximum Power Point Tracking* mode trying to regulate the battery voltage towards the *Float* voltage set point. Note: *Charge Timer (ChgT)* is inactive in the *Float* state.

MPPT EQ The *equalization cycle* has started and the Charge Controller is trying to regulate at the *Equalization* voltage set point. *EQ* is **not** battery temperature compensated. During an equalization cycle, *EQ 0:00* will be displayed along with the *EQ* time in hours and minutes. The AC/DC loads should be turned off/minimized and the battery charged so the Charge Controller can quickly reach the *EQ* voltage set point. Otherwise, the Charge Controller may not reach or maintain the *EQ* cycle.

New VOC The Charge Controller is acquiring a new open circuit panel voltage (VOC).

OvrCurrent If more than 6A flowing *from* the battery or more than 100A flowing *to* the battery. To reinitiate power production, press "RSTRT" in the "Misc" menu.

Over Temp (Very rare) Either the Charge Controller is too hot or its internal temperature sensor is shorted. If this message appears, carefully check if the Charge Controller's heat sink is extremely hot. The heat generated by the Charge Controller, and therefore its losses, is proportional to input voltage times output current. To help control its operating temperature, avoid installing the Charge Controller in direct sunlight

Re-Cal There are certain abnormal conditions that can confuse the current measuring method in the Charge Controller. When and if one happens, the Charge Controller will temporarily stop and re-calibrate. This may happen because of negative current, i.e., current flowing from the battery, or a tripped PV breaker. A new VOC is also acquired during a Re-Cal.

Sleeping The PV voltage is two volts less than the battery voltage. This may also appear during the day when the Charge Controller is transitioning between certain states, or due to other conditions.

SysError (Very rare) System Error indicates an internal non-volatile memory error. The unit will stop operating when this message is displayed. Call the factory if you see this message (360-435-6030).

Tracking In *Auto-Sweep MPPT* mode, the Charge Controller is doing an initial tracking of the panel voltage from VOC towards battery voltage after wakeup. This display also appears when the controller transitions from a target set point (*Absorbing/ Floating/EQ 0:00*) to the MPPT state (*MPPT Bulk/ MPPT Float/ MPPT EQ*).

Unloaded The battery terminals abruptly unload. *Unloaded* is also displayed if the battery breaker trips while MPPTing or the battery voltage is set too low.

Wakeup As the PV open circuit voltage (VOC) rises above the battery system voltage by two volts, the Charge Controller prepares to deliver power to the batteries. During this period, the Charge Controller is calculating the pulse width modulation (PWM) duty cycles, turning on power supply voltages in the proper sequences, and making internal calibrations. At wakeup, the Charge Controller closes its relays and then starts tracking the input voltage (the "initial" tracking) towards the battery voltage. At dawn and dusk this may happen many times until there is (or is not) enough power from the PV array to keep going. Wakeup is also a time when the Charge Controller acquires a new VOC.

Zzzzz... At night (after 3 hours of continuous Sleeping) the Charge Controller will display *Zzzzz...* until the next wakeup. At the next wakeup, (usually the next morning), the daily statistics of a single Charge Controller, (AmpHours, kWh, etc.), will accumulate into the total statistics and then the displayed daily statistics and *End of Day* summary will clear. A *Bulk* charge will automatically initiate at the next Wakeup. A Charge Controller combined with a HUB and a MATE will log at midnight.

23. MATE-Displayed Charge Controller Screens

Status Mode Screens

The Charge Controller STATUS MODE Screens displayed on the optional OutBack MATE (Rev 4.0.4 or greater) include MODE, METER, and SET (SETPOINT). In STATUS Mode, these functions can be viewed by the MATE, but not changed. Please see the *MATE Installation and User Manual* for more information.

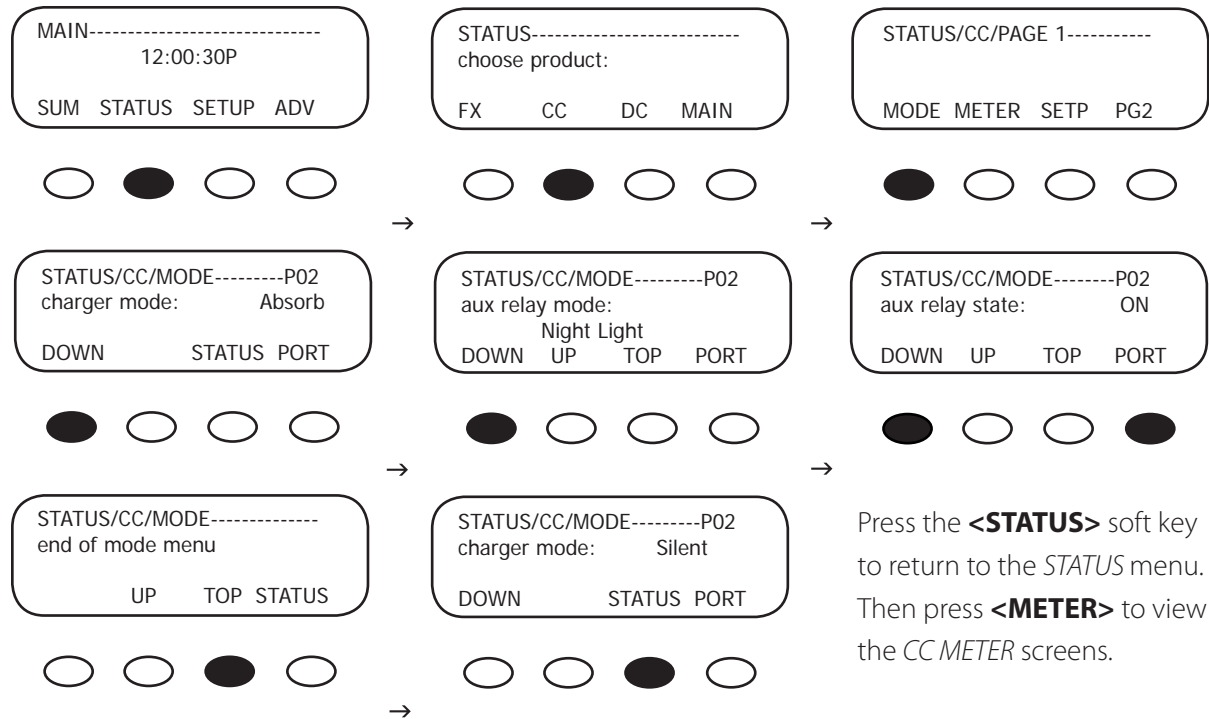

Charge Controller MODE Screens

- *charger mode*: displays one of five charging stages (Bulk, Absorption, Float, Silent, or Equalization)
- *aux relay mode*: displays one of nine Charge Controller AUX modes (*Vent Fan, PV Trigger, ERROR OUTPUT, Night Light, Float, Diversion: Relay, Diversion: Solid St, Low Batt(ery) Disconnect, Remote*)
- *aux relay state*: indicates if the AUX is ON or OFF

MATE-Displayed Charge Controller Status Meter Screens

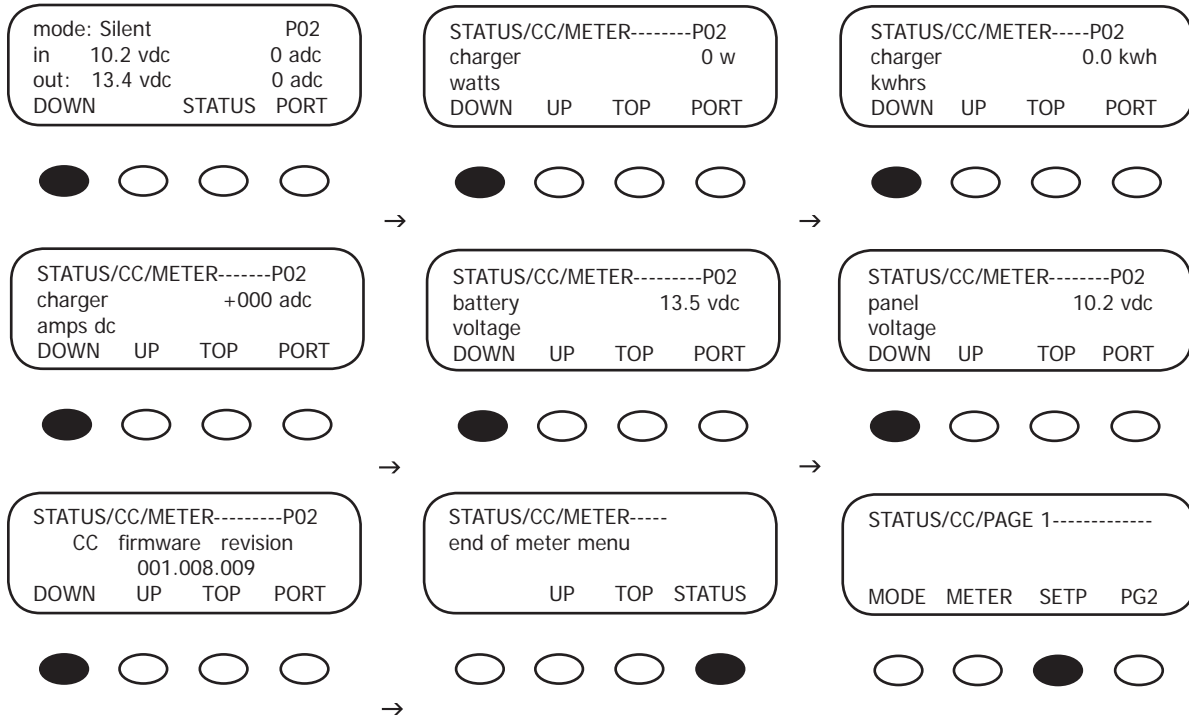

Press <SETP> to view the SETPOINT screens

FLEXmax METER Screens

- *mode/pv/in/bat/out*: displays the charger mode, the PV array voltage, the incoming PV amps, the battery voltage, and the outgoing amps to the battery
- *charger watts*: charger output measured in watts
- *charger kWhrs*: kilowatt hours produced today by the Charge Controller
- *charger amps dc*: the amount of amperage the Charge Controller is sending to the battery
- *battery voltage*: current battery voltage
- *panel voltage*: current voltage from the PV array

MATE-Displayed Charge Controller STATUS SETPT (SET POINT) Screen

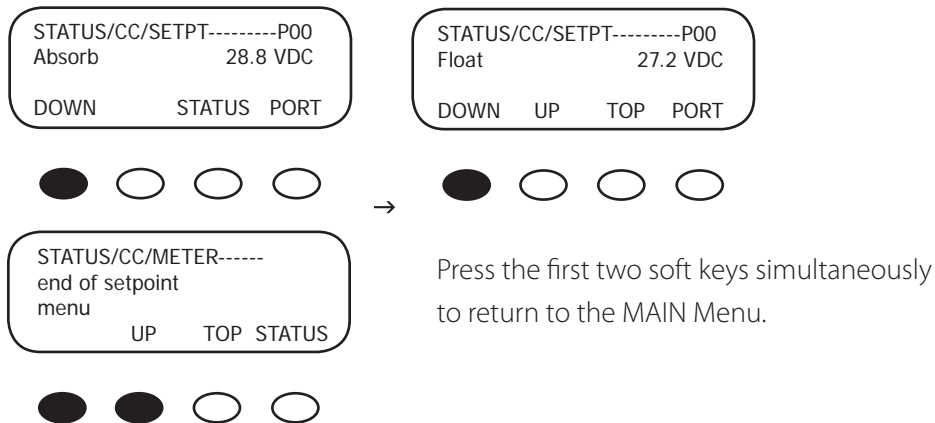

CC SETP(OINT) Screens

- *Absorb*: displays the voltage that initiates and maintains the Absorb cycle
- *Float*: displays the voltage that begins the Float cycle and is maintained during this cycle

MATE-Displayed Charge Controller Advanced Screens

The Charge Controller Advanced Screens displayed on the optional OutBack MATE include CHGR (CHARGER), CCADV (ADVANCED), EQ, AND AUX. The *Advanced* screens allow the user to change various values and set points.

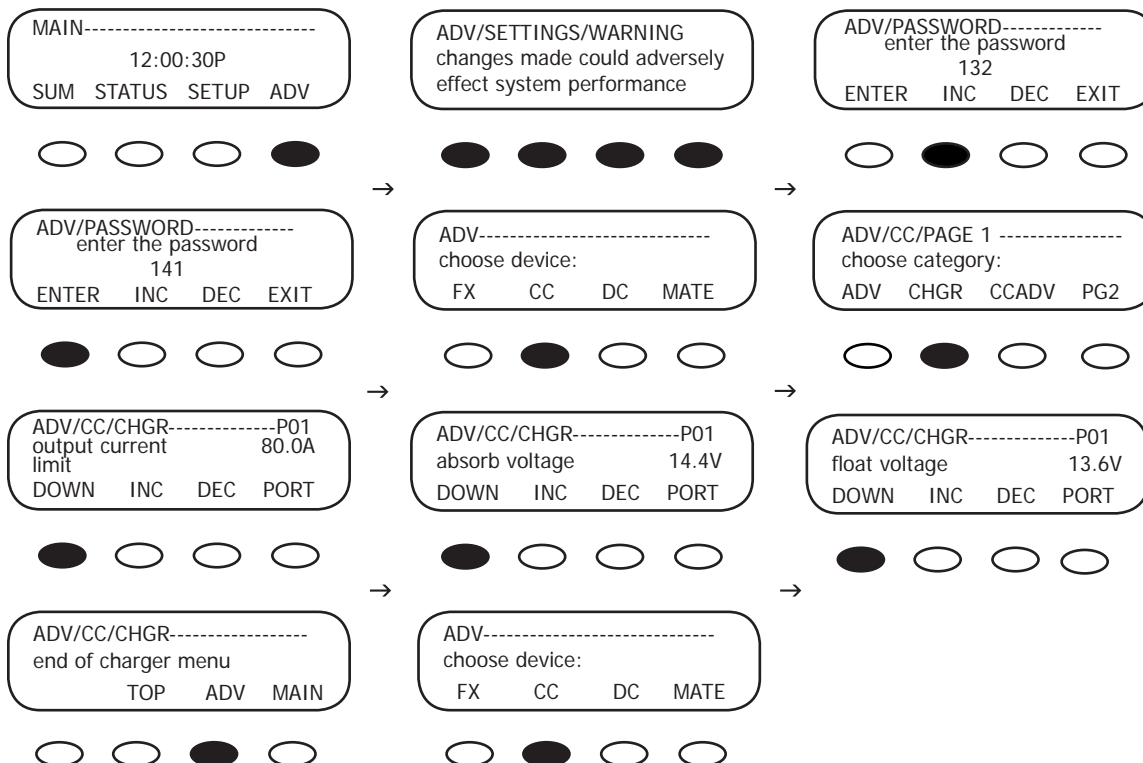

24. Charge Controller Advanced Menu

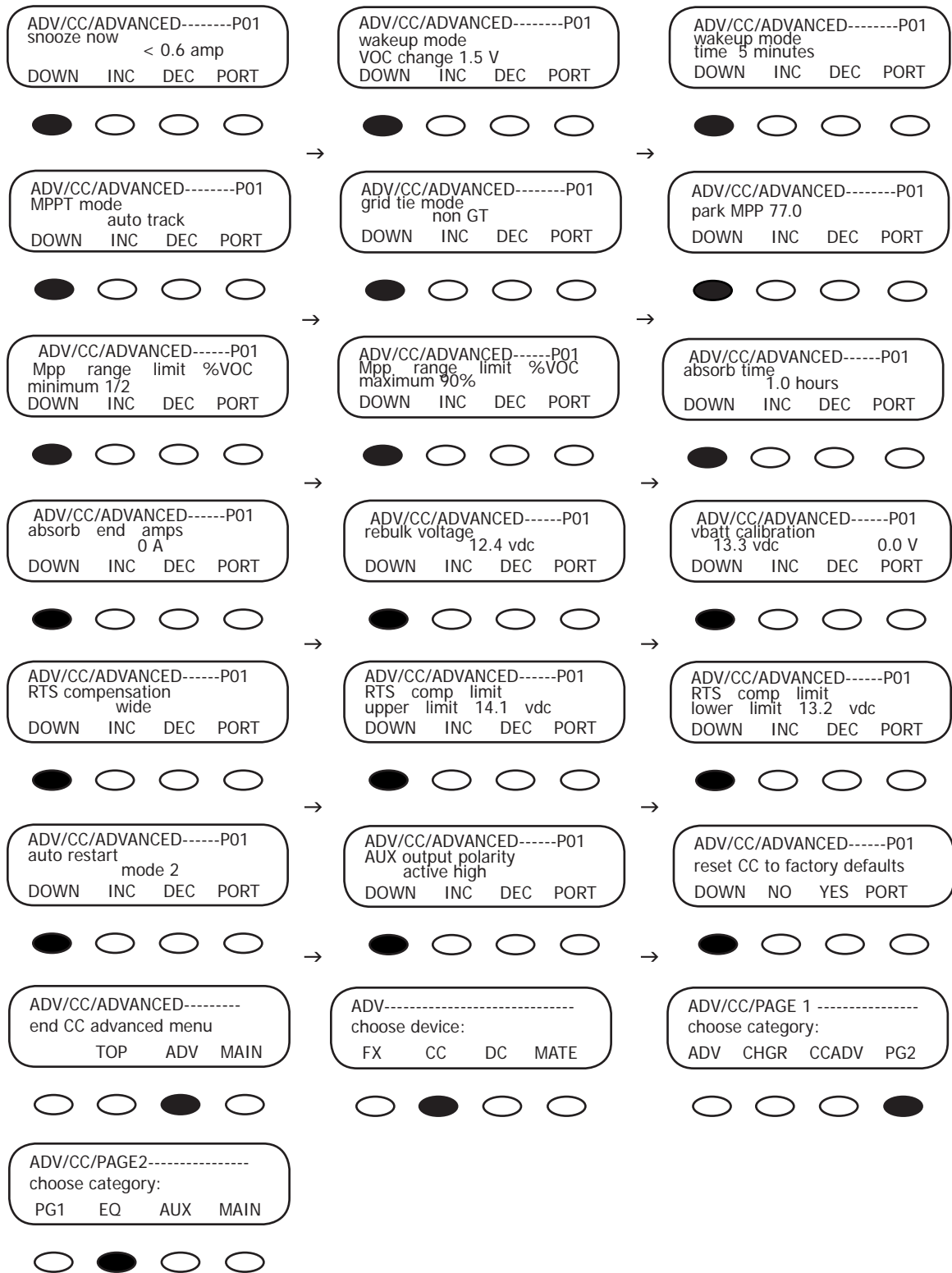

Charge Controller EQ Screens

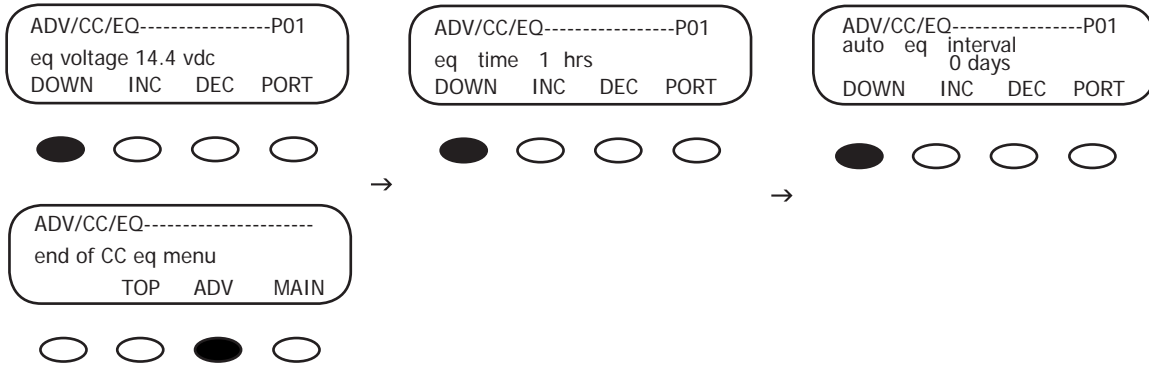

Charge Controller AUX Screens

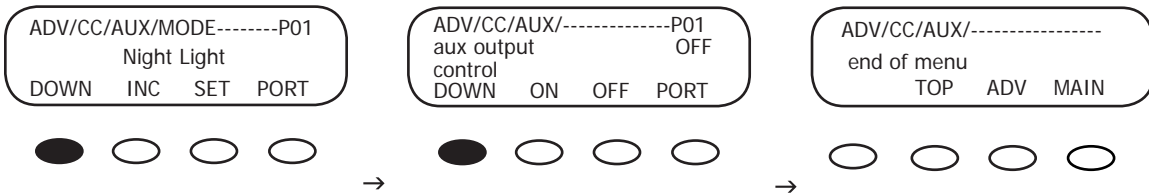

Charge Controller Displayed Screens

Charge Controller LOGGING Screens

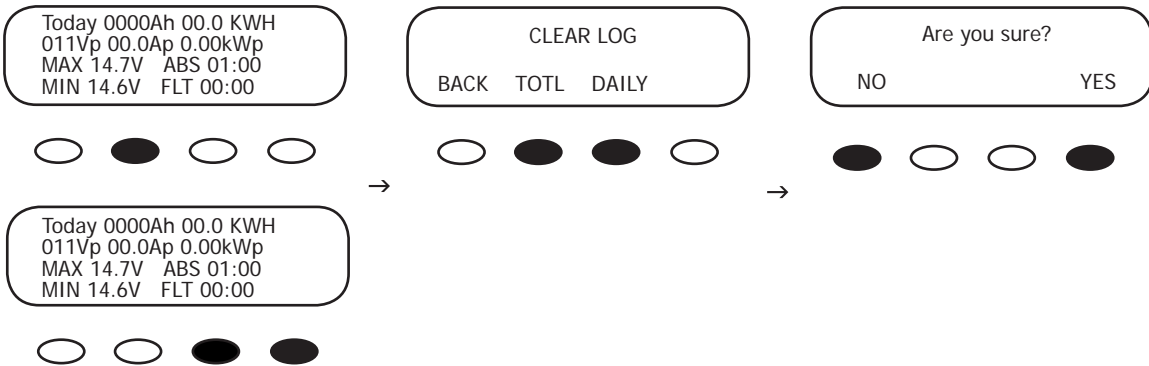

Charge Controller STATS Screens

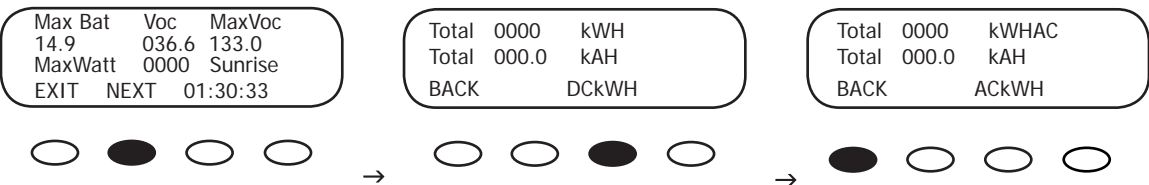

ADVANCED MENU
Park Mpp
77% VOC
EXIT NEXT +VOC +Min

ADVANCED MENU
Mpp Range Limit %Voc
Min Max
EXIT NEXT 1/2 90%

ADVANCED MENU
Absorb Time
01.0 hours
EXIT NEXT - +

ADVANCED MENU
Absorb End Amps
00 A
EXIT NEXT - +

ADVANCED MENU
Rebulk Voltage
12.4V
EXIT NEXT - +

ADVANCED MENU
Vbatt Calibration
14.9V 0.0V
EXIT NEXT -V +V

ADVANCED MENU
RTS Compensation
A 14.4V F 13.6V
EXIT NEXT WIDE

ADVANCED MENU
Auto Restart
MODE 2
EXIT NEXT MODE

ADVANCED MENU
Aux Polarity
Active High
EXIT NEXT MODE

ADVANCED MENU
Reset to Defaults?
EXIT NEXT RESET

PUSH TWICE
Charger Aux Light
EQ Misc Advanced
Logging Stats
EXIT ← → GO

PUSH THE ARROW KEY AND THEN PUSH GO
Today 0000AH 00.0kWH
012Vp 00.0Ap 0.00kWp
MAX 14.9V ABS 00:00
MIN 14.8V FLT 00:00

PUSH ONCE
In 11.6V 0.0 A
Out 14.1V 0.0 A
0.000kW 0.0 kWH
Aux: OFF Zzzzzz.....

Charger Aux Light
EQ Misc Advanced
Logging → Stats
EXIT ← → GO

PUSH THE ARROW KEY AND THEN PUSH GO
Max Bat Voc MaxVoc
15.0 000.0 030.4
MaxWatt 0000 Sunrise
EXIT NEXT 00:31:50

Total 0307 kWh
Total 000.0 kAH
BACK DCKWH

TO VIEW SOFTWARE REVISION

Charger Aux Light
EQ Misc → Advanced
Logging Stats
EXIT ← → GO

PUSH AND HOLD THE FIRST SOFT KEY

REVISION
001.008.009

EXTENDED PLAYMODE

→ Charger Aux Light
EQ Misc Advanced
Logging Stats
EXIT ← → GO

PRESS AND HOLD THE FIRST KEY AND THEN PRESS AND HOLD THE THIRD KEY. RELEASE THE THIRD KEY AND PRESS AGAIN TO TOGGLE THE EXTENDED PLAYMODE ON AND OFF.

X on

X off

26. Troubleshooting Guide

Charge Controller does not boot/power-up (blank LCD)

Be sure to check out the OutBack customer and user forum at www.outbackpower.com/forum/ for more Charge Controller information.

- Check the battery connection and polarity.
 - Reverse polarity or an improper connection will cause power-up issues.
- Check the battery breaker.
 - Ensure that the battery breaker is sized appropriately.
- A battery voltage below 10.5VDC may not power up the Charge Controller (measure the battery-side of wire lugs).
- If the Charge Controller still does not power up, call the factory for additional support.

Charge Controller is always SLEEPING

- If the battery voltage is at or above the ABSORB voltage set point (compensated ABSORB voltage), the Charge Controller will not wake up.
- The PV voltage has to be at least two volts greater than the battery voltage for the initial wakeup.
- Check the PV array breaker (or fuse).
- Confirm the PV array breaker (or fuse) is sized appropriately.
- Which State (in **MISC** Menu) is it at? Is it transitioning between 00 and 01? Is it in GT mode and connected to a MATE?
 - GT mode is only applicable with a HUB 4 or HUB 10 installations with a grid-tie compatible MATE.
- Does the PV array voltage on the display rise with the PV breaker OFF, but reads 000 with the PV breaker on?
 - If so, the PV array polarity connection on the Charge Controller maybe reversed or the PV lines could be shorted.
- Does the PV voltage still read 000 with the PV breaker off after a minute?
 - Call the factory for support.
- Have you checked the short circuit current of the PV array?
 - Use a multi-meter to determine if a short circuit current is detected. The short circuit current test will not harm the array.

Charge Controller not producing expected power

- Clouds, partial shading, or dirty panels can cause poor performance.
- The lower current limit set point in the *Charger* menu will yield a loss of power or poor performance symptoms.

- Are the batteries charged? Is the Charge Controller in the *Absorbing* or *Float* stage? If either case is true, the Charge Controller will produce enough power to regulate the voltage at the *ABSORB* or *FLOAT* set point voltage, therefore, requiring less power in these modes.
- What is the short circuit current of the PV array? Use a multi-meter to determine if a short circuit current is as expected. There might be a loose PV array connection.
- If the PV array voltage is close to the battery voltage, the panels could be warm/hot causing the Maximum Power Point to be at or lower than the battery voltage.
- Is it in *U-Pick* mode?

Charge Controller is not equalizing

- Has the *EQ* cycle been initiated?
 - In the EQ Menu, press *START* to begin process. When the EQ cycle has been initiated, *EQ-MPPT* will be displayed.
- The EQ cycle has been initiated, but the battery is not equalizing.
 - The *EQ* cycle will begin when the target *EQ* set point voltage has been reached. A small array or cloudy weather will delay the *EQ* cycle. Accordingly, running too many AC and/or DC loads will delay the *EQ* cycle, too.
- An EQ set point that is too high relative to the battery voltage will delay the *EQ* cycle.
- If the PV array voltage is close to the battery voltage, the panels could be warm/hot causing the Maximum Power Point to be at or lower than the battery voltage which can delay the *EQ* cycle.

Charge Controller Battery Temperature Compensated Voltage

- Only the OutBack RTS (remote temperature sensor) can be used with the Charge Controller.
- The battery voltage can rise above the *ABSORBING* and *FLOAT* voltage set points if the battery temperature is < 77°F or fall below the *ABSORBING* and *FLOAT* voltage if the battery temperature is > 77°F.
- Why does the Charge Controller show *BatTmpErr* on the *STATUS* screen?
 - The RTS is faulty or damaged. Disconnect the RTS from the RTS jack to resume normal operation.

Charge Controller Internal Fan

- The internal fan will only run when the internal temperature has reached approximately 112°F. The fan will continue running until the internal temperature is less than 104°F.

Charge Controller is beeping

- When the Charge Controller is in *Extended Play* mode, the array is very hot, and the MPP is close to the battery voltage, or the nominal PV voltage is higher than the nominal battery voltage, beeping can occur. To disable the *Extended Play* feature, go to the MAIN Menu and press and hold the #1 soft key until the Charge Controller's software version appears on the screen. Continue pressing the #1 soft key and press the #3 soft key at the same time until *X Off* displays on the screen. To reactivate *Extended Play*, repeat these steps and hold the #3 soft key until *X On* displays. *Extended Play* is meant to optimize the performance of a hot array, but isn't critical to efficient Charge Controller operations.

To enable/open the FLEXmax SELECT VERSION screens:

- Turn off the DC and array breakers
- Press and hold the first and third soft keys
- Turn on the battery breaker
- Follow the SELECT VERSION screen instructions from the beginning of the manual
- Rebooting the Charge Controller *like this* will return all the values and set points to the factory defaults.

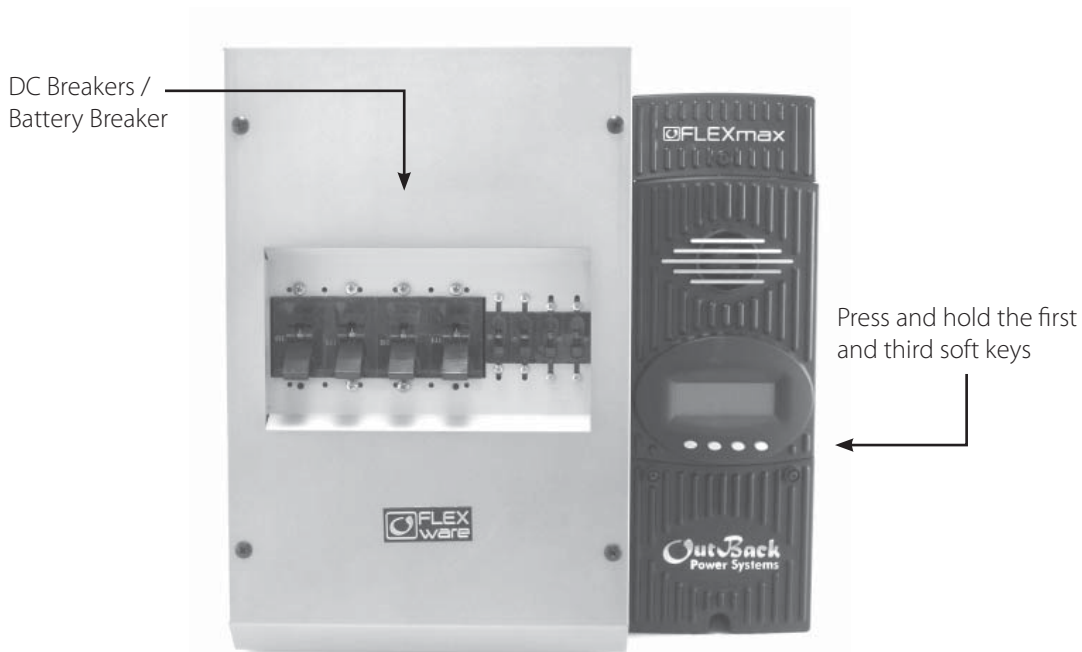

Figure 9

27. Typical Array Sizing Guide

Below is a list of recommended array sizing for the Charge Controller for various nominal voltage batteries:

Nominal Battery Voltage	Recommended Array Size (in watts, Standard Test Conditions)	
	FLEXmax 80	FLEXmax 60
12V	1250W	800W
24V	2500W	1600W
36V	3750W	2400W
48V	5000W	3200W
60V	6250W	4000W

The Charge Controller PV MPPT Charge Controller is capable of an input open circuit voltage (VOC) of up to 150 VDC. Cooler climates can cause the VOC to rise above the panel VOC rating. In climates that observe temperatures less than approximately 5° F, a VOC greater than 125 VDC is **not** recommended.

When sizing an array, it is recommended that the nominal array voltage be higher than the nominal battery voltage. Below is a list of recommended nominal array sizing:

Nominal Battery Voltage	Nominal Array Voltage (recommended)
12V	24V (or higher)*
24V	36V (or higher)*
36V	48V (or higher)*
48V	60 V (or higher)*
60V	60V (low temp is less than 5°F) or 72V (low temp is greater than 5°F)

* When sizing an array to charge controller with a distance of 70 feet or greater, OutBack recommends the nominal array voltage be slightly higher than the *recommended* nominal array voltage. Example: A 36VDC nominal array recharging a 12V nominal battery with an array to charge controller distance of about 70 feet or greater. Sizing the nominal array voltage higher than the nominal battery voltage ensures that the Maximum Power Point is always above the battery voltage. The Maximum Power Point will decrease as the panels warm up, thus lowering the output of the array. The Charge Controller Charge Controller will not be able to boost the output if the Maximum Power Point of the array is at or lower than the battery voltage.

28. STANDARD vs. AUSTRALIAN DEFAULT SETTINGS

The Australian version Charge Controller has a few default settings that differ from the Standard version default settings. However, there are no differences in performance and efficiency between the two versions. The Standard and Australian version can be identified as follows:

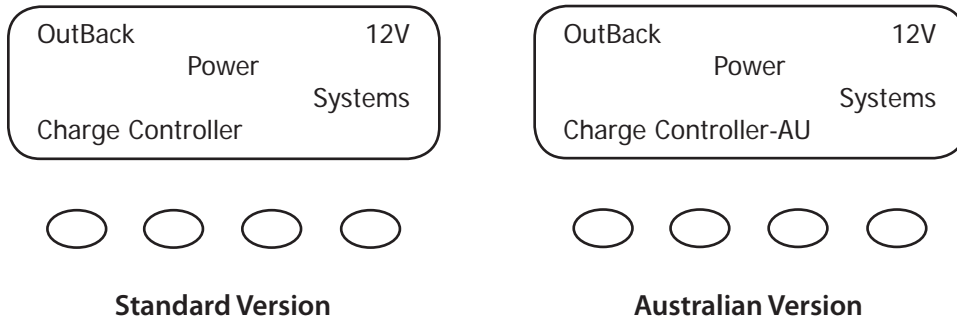

Below are a few default setting differences between the Standard and Australian version.

Settings	Standard	Australian
Charger	Absorb Float	Absorb Float
12V	4.4V 13.6V	14.4V 13.8V
24V	28.8V 27.2V	28.8V 27.6V
36V	43.2V 40.8V	43.2V 41.4V
48V	57.6V 54.4V	57.6V 55.2V
60V	72.0V 68.0V	72.0V 69.0V
Equalize	Equalize Volts	Equalize Volts
12V	14.4	14.7
24V	28.8	29.4
36V	43.2	44.1
48V	57.6	58.8
60V	72.0	73.5
Equalize Time	01 Hours	03 Hours

29. Wire Distance Chart

To meet NEC compliance (North America), the largest PV array that can be connected to a FLEXmax 80 must have a rated short-circuit current of 64 amps or less and 48 amps or less for a FLEXmax 60. The following charts show the maximum distance of various gauge two-conductor copper wire from the PV array to the Charge Controller with a 1.5% maximum voltage drop. Temperature and conduit fill corrections may be required. Using a higher voltage PV array with a low voltage battery system allows you to use a much smaller wire size or go up to 5 times as far with the same gauge wire.

FLEXmax 60 and FLEXmax 80 (The figures below assume THWN 75° C two-conductor copper wire and allow for a 1.5% voltage drop)

12V PV ARRAY (16v Vmp)

WIRE GAUGE →	#8	#6	#4	#3	#2	#1	#1/0	#2/0	#3/0	#4/0
10	15	24	39	49	62	78	98	124	157	197
20	8	12	19	24	31	39	49	62	78	99
30	5	8	13	16	21	26	33	41	52	66
40	4	6	10	12	15	19	25	31	39	49
50	3	5	8	10	12	16	20	25	31	39
60	3	4	6	8	10	13	16	21	26	33
70	2	3	6	7	9	11	14	18	22	28
80	2	3	5	6	8	10	12	16	20	25

24V PV ARRAY (32v Vmp)

WIRE GAUGE →	#8	#6	#4	#3	#2	#1	#1/0	#2/0	#3/0	#4/0
10	31	49	78	98	124	156	197	248	313	395
20	15	24	39	49	62	78	98	124	157	197
30	10	16	26	33	41	52	66	83	104	132
40	8	12	19	24	31	39	49	62	78	99
50	6	10	16	20	25	31	39	50	63	79
60	5	8	13	16	21	26	33	41	52	66
70	4	7	11	14	18	22	28	35	45	56
80	4	6	10	12	15	19	25	31	39	49

36V PV ARRAY (48v Vmp)

WIRE GAUGE →	#8	#6	#4	#3	#2	#1	#1/0	#2/0	#3/0	#4/0
10	46	73	117	147	186	234	295	372	470	592
20	23	37	58	73	93	117	148	186	235	296
30	15	24	39	49	62	78	98	124	157	197
40	12	18	29	37	46	58	74	93	117	148
50	9	15	23	29	37	47	59	74	94	118
60	8	12	19	24	31	39	49	62	78	99
70	7	10	17	21	27	33	42	53	67	85
80	6	9	15	18	23	29	37	47	59	74

METRIC

#8...8.37mm²
 #6...13.30mm²
 #4...21.15mm²
 #3...26.7mm²
 #2...33.6mm²
 #1/0...53.5mm²
 #2/0...67.4mm²
 #4/0...107mm²

NOTE: Numbers in bold might not meet NEC requirements

48V PV ARRAY (64v Vmp)

WIRE GAUGE →	#8	#6	#4	#3	#2	#1	#1/0	#2/0	#3/0	#4/0
10	62	98	156	196	247	312	393	496	627	789
20	31	49	78	98	124	156	197	248	313	395
30	21	33	52	65	82	104	131	165	209	263
40	15	24	39	49	62	78	98	124	157	197
50	12	20	31	39	49	62	79	99	125	158
60	10	16	26	33	41	52	66	83	104	132
70	9	14	22	28	35	45	56	71	90	113
80	8	12	19	24	31	39	49	62	78	99

60V PV ARRAY (80v Vmp)

WIRE GAUGE →	#8	#6	#4	#3	#2	#1	#1/0	#2/0	#3/0	#4/0
10	77	122	195	245	309	390	492	620	783	987
20	39	61	97	122	155	195	246	310	392	493
30	26	41	65	82	103	130	164	207	261	329
40	19	31	49	61	77	97	123	155	196	247
50	15	24	39	49	62	78	98	124	157	197
60	13	20	32	41	52	65	82	103	131	164
70	11	17	28	35	44	56	70	89	112	141
80	10	15	24	31	39	49	61	78	98	123

72V PV ARRAY (96v Vmp)

WIRE GAUGE →	#8	#6	#4	#3	#2	#1	#1/0	#2/0	#3/0	#4/0
10	93	147	234	294	371	468	590	745	940	1184
20	46	73	117	147	186	234	295	372	470	592
30	31	49	78	98	124	156	197	248	313	395
40	23	37	58	73	93	117	148	186	235	296
50	19	29	47	59	74	94	118	149	188	237
60	15	24	39	49	62	78	98	124	157	197
70	13	21	33	42	53	67	84	106	134	169
80	12	18	29	37	46	58	74	93	117	148

NOTE: Numbers in bold might not meet NEC requirements

METRIC

#8...8.37mm ²
#6...13.30mm ²
#4...21.15mm ²
#3...26.7mm ²
#2...33.6mm ²
#1/0...53.5mm ²
#2/0...67.4mm ²
#4/0...107mm ²

30. WIRE AND DISCONNECT SIZING

FLEXmax 80

The Charge Controller is a buck type converter with the following properties:

- 80 amp DC output current limit (default setting)
- Listed to operate continuously at 80 amps (40°C/104° F)

With an 80 amp Charge Controller output current limit and PV array output higher than 80 amps offers little, if any, current boosting or Maximum Power Point Tracking advantage; in effect, any excess power beyond 80 amps is lost.

For NEC* compliance and the Charge Controller's 80 amp output rating / MPPT capabilities, the largest PV array input *must not exceed* a rated short-circuit current of 64 amps.

Battery Side of the Controller

- All OutBack Power circuit breakers (OBB-XX) are 100% continuous-rated type breakers
- The conductors connected to the breakers must have a 125% safety factor applied (i.e., an 80 amp breaker must have a 100-amp conductor connected when used at its full 80-amp rating)

PV Side of the Controller

- UL* requires a 125% safety multiplier (before NEC calculations)
- NEC* requires a 125% safety multiplier (after UL calculations).
- The 156% safety multiplier is specific in the NEC* to PV applications only – this “dual” 125% multiplier is used because a PV array can produce above its rated output in some conditions.

NEC Compliance

- When the 156% safety multiplier is applied, the resulting conductor amperage required is still 100-amps (1.56 X 64A) and an 80 amp breaker may be used (100% continuous duty rated breaker).
- When a PV array is configured for a higher nominal input voltage (such as 72V PV array), the PV input conductor can be sized smaller depending on the step-down ratio and the maximum short circuit current available.

NOTE: The input breaker must also be sized smaller; it cannot be the normal 80 amp with conductor smaller than #4 AWG. (21.1mm²)

* North America

WIRE AND DISCONNECT SIZING

FLEXmax60

The MX60 has a 60 amp current output limit (default) and is listed to operate continuously at 60 amps depending on the nominal PV array voltage and the nominal battery voltage. There is no 80% de-rating as required by the NEC* for fuses, conductors, and most circuit breakers.

The MX60 is a buck type converter and cannot boost the output current when the PV array peak power point voltage is at or below the battery voltage as may happen on hot days in 24 VDC PV and a 24 VDC battery system or a 48 VDC PV and a 48 VDC battery system.

To meet minimum NEC requirements (NEC 310.15, 690.8, 9), the output conductor should have an ampacity of 75 amps after any temperature and conduit fill corrections. This would normally indicate that the output conductors be 6 AWG (5.83 mm), but a larger size may be required if there are temperature and/or conduit fill corrections required. With an output conductor rated at 75 amps (1.25 X the continuous output current), the OutBack OBB-60 breaker—rated for continuous 100% duty at 60 amps—can be used to provide the code-required disconnect and output circuit over current protection.

The PV array output connected to the MX60 input may be as high 60 amps, but at this current level, there is very little (if any) current boosting or maximum power-point tracking due to the 60-amp output current limit. Additionally, the input current may exceed 60 amps on bright sunny days and any excess power would be lost. The size and ampacity of the input conductors must be selected to handle 1.56 times the short-circuit current of the PV array. Any disconnect or circuit breaker connected to the input conductors must also be rated at 1.56** times the short-circuit current for the PV array unless the breaker is rated for 100% duty in its enclosure. If that is the case, the circuit breaker may be rated at 1.25 times the PV array short-circuit current. OutBack OBB-XX breakers are 100% duty rated breakers.

In terms of NEC compliance and the MX60's 60-amp output rating, the largest PV array it can connect to should have a rated short-circuit current of 48 amps. This meets NEC requirements and allows the MX60 to perform maximum power-point tracking functions. The following charts show maximum distance in feet of various gauge two-conductor copper wire from the PV array to the MX60 with a 1.5% maximum voltage drop. Temperature and conduit fill corrections may be required.

*When NEC does not apply, see local code requirements.

31. WIRING COMPARTMENT

The wiring terminals and compartment of the Charge Controller Charge Controller are fully compliant with all NEC and UL requirements. *The following summary is specific for North American applications where NEC and UL standards govern installations.*

Recommended Conductor and Breaker Sizes for the Charge Controller

Output Rating at 80 amps

If the output current of the Charge Controller is expected to reach the maximum output level of 80 amps:

- #3 or #2 AWG conductor must be used with an 80 amp breaker (100% continuous duty rated breaker)
- The minimum recommended battery conductor is #3* AWG
- The maximum recommended battery conductor is #2** AWG

METRIC
#4...21.15mm ²
#3...26.7mm ²
#2...33.6mm ²

* #3 AWG conductor can be installed through the side, back or bottom knockouts

** #2 AWG conductor must be installed on the side or back knockout to meet the specific UL requirements for wire bending room standards

- 1" conduit knockout is approved for up to three #2 AWG conductors
- For short conduit runs (less than 24"), a higher conduit fill is acceptable* —three #2 AWG wires

Please reference the NEC Appendix "C" in the back of the book. You must refer to the table representing the type of conduit you will be using to find the maximum number of conductors allowed within the conduit you will be using.

Output Rating less than 64 amps

If the output current of the Charge Controller is expected to be less than 64 amps:

- An 80 amp breaker and #4 AWG conductors can be used on the battery side.
- The PV array short circuit current must be less than 48 amps and the #4 conductor will be acceptable with an 80 amp breaker.

32. Charge Controller MULTI-STAGE BATTERY CHARGING

The Charge Controller charge controller is a sophisticated, multi-stage battery charger that uses several regulation stages to allow fast recharging of the battery system while ensuring a long battery life. This process can be used with both sealed and non-sealed batteries. The Charge Controller has a preset recharging voltage set points (Absorb & Float) for the selected nominal battery voltage, however, always follow the battery manufacturer's recommended charging regulation voltages. The Charge Controller charging regulation stages correspond to the chart in Figure 10.

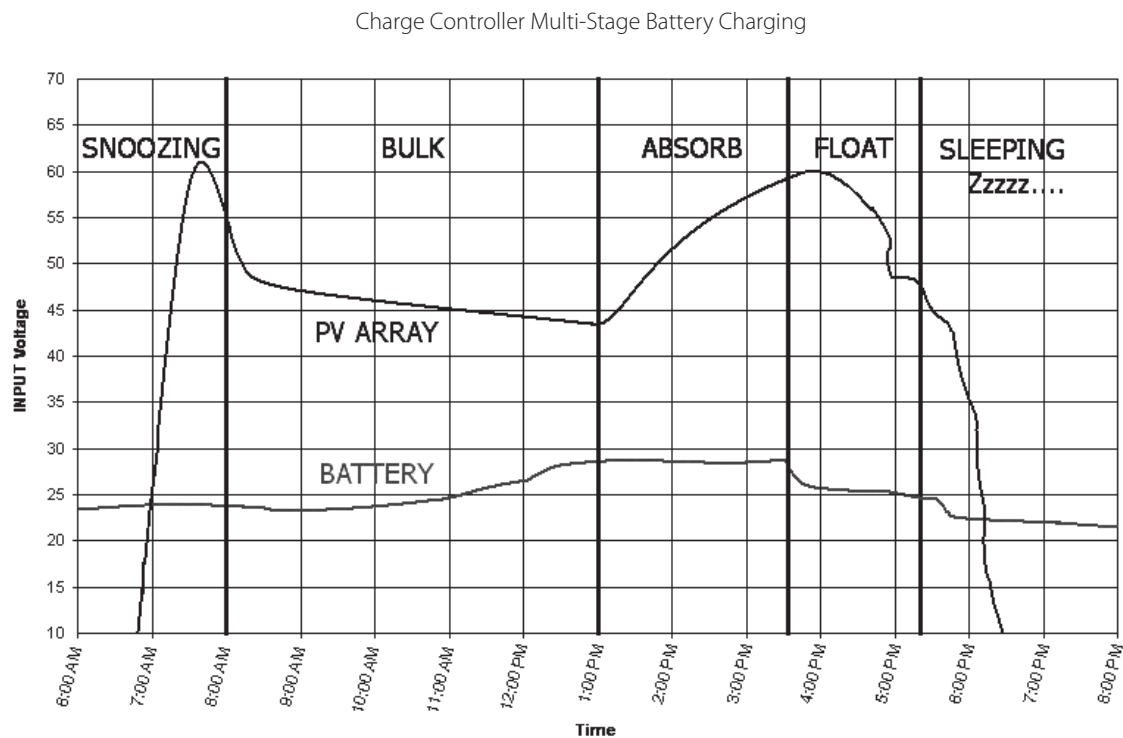

Figure 10

NOTE: In BULK, the Charge Controller will charge as long as necessary to complete the cycle, regardless of the timer's set points.

BULK cycle provides the maximum power to the battery –the voltage increases while recharging.

A Bulk cycle is automatically initiated when the battery voltage is below the *Absorb* and *Float** recharge voltage set points. The *Bulk* cycle will continue until the *Absorb* voltage set point is achieved. *MPPT Bulk* is displayed on the screen.

ABSORBING cycle limits the amount of power going to the battery—the voltage is held constant.

The *Absorb* cycle will continue for the duration of the *Bulk* cycle or until the 2 hour (default) *Absorb* time limit is reached. For example, if a *Bulk* cycle takes 1 hour to reach the *Absorb* voltage set point, then the *Absorb* cycle will continue for 1 hour as well. However, if a Bulk cycle takes 3 hours to reach the *Absorb* voltage set point, then the *Absorb* cycle will continue for 2 hours only. A *Bulk* cycle will be re-initiated if the battery voltage is not sustained at the *Absorb* voltage set point. *Absorbing* is displayed on the screen at this time.

FLOAT cycle reduces the recharging voltage to prevent overcharging of the batteries.

A *Float* cycle follows after the *Absorb* cycle is completed; *Float* is displayed on the screen. The Charge Controller **will not** re-initiate another *Bulk* cycle if the *Float* voltage set point is not sustained*. *FMPPT* is displayed. However, it will continue to recharge the battery until the *Float* voltage set point is reached.

* A *Bulk* cycle can be auto-initiated if the battery voltage falls below the *Float* voltage set point and the *Re-Bulk* voltage option is set.

33. BATTERY TEMPERATURE COMPENSATED VOLTAGE SET POINT

The temperature of a battery has an impact on the recharging process—in higher ambient temperatures, the regulation set points (*Absorb* and *Float*) need to be reduced to prevent overcharging of the batteries. In lower ambient temperature conditions, the voltage regulation set points need to be increased to ensure complete recharging of the batteries.

The default charger settings of the Charge Controller are based on typical lead acid battery systems. *Always ensure the Absorb and Float voltage regulation set points are set to the recommended battery manufacturer's recharging regulation voltages.*

Non-Battery Temperature Compensated System

If a battery remote temperature sensor is not available the *Absorb* and *Float* voltage regulation set points can be adjusted for the expected weather conditions. The following table shows the appropriate adjustments for both *Absorb* and *Float* voltage regulation set points for weather conditions above or below 77°F / 25 C

EXPECTED TEMPERATURE	ADJUST SET POINT	12V	24V	48V
Average = 95°F / 35°C	Subtract	0.30V	0.60V	1.20V
Average = 86°F / 30°C	Subtract	0.15V	0.30V	0.60V

Average = 68 F / 20°C	Add	0.15V	0.3 V	0.60V
Average = 59°F / 15°C	Add	0.30V	0.60V	1.20V

Battery Temperature Compensated System

A battery remote temperature sensor (RTS) will **automatically** compensate the *Absorb* and *Float* voltage **relative** to the *Absorb* and *Float* set points in the *Charger* menu. Please reference page 49 of this manual for adjusting the upper and lower battery compensated limits.

Battery temperature compensation with other slopes

The Charge Controller uses a 5mV per degree C per cell (2V) compensation slope required by UL. For other slopes, you may be able to pick a different battery voltage and change the charger *Absorb* and *Float* voltage settings to achieve a more or less aggressive slope. If going lower in voltage, reduce the *Float* voltage first, since the *Absorb* voltage will not be adjustable below the *Float* voltage setting. If going higher in voltage, increase the *Absorb* setting first before raising the *Float* voltage above the present setting. Here is a table of Charge Controller compensation based on system voltage for reference:

12V system	-30mV/degree C
24V system	-60mV/degree C
36V system	-90mV/degree C
48V system	-120mV/degree C
60V system	-150mV/degree C

34. SUGGESTED BATTERY CHARGER SET POINTS

The battery manufacturer should provide you with specific instructions on the following maintenance and voltage set point limits for the specific batteries. The following information can be used when the manufacturer's information is not available.

SEALED LEAD ACID – AGM / GEL	12V	24V	48V
ABSORB voltage set point	14.4V	28.8V	57.6V
FLOAT voltage set point	13.4V	26.8V	53.6V
NON-SEALED LEAD ACID	12V	24V	48V
ABSORB voltage set point	14.8V	29.6V	59.2V
FLOAT voltage set point	13.8V	27.6V	55.2V

NOTE: Higher settings can be used with non-sealed batteries, but water consumption will be greater and excessive temperatures when recharging may occur.

Battery Voltage and State of Charge

A battery's voltage can be used as a guideline to estimate the amount of power stored in the battery that is available for use. When referencing the battery voltage on the display, be sure the battery is not under significant recharging or heavy loads. Otherwise, the DC voltage is not reflective of the battery state of cycle. Often the best time to check the battery voltage is in the morning (pre-charging) or at night (post-charging), with the battery disconnected from charging sources and loads and a rest for at least three hours.

Operation of a battery below 50% state of cycle will adversely affect the long term health of the battery system and will result in premature failure. Keeping the battery above the 50% level and recharging it completely once a month will ensure proper operation and good performance.

STATE OF CHARGE

Nominal Battery Voltage	Charged	Good (~75%)	Average (~50%)	Low (~25%)	Discharged
12V	over 12.6V	12.3V	12.0V	11.7V	under 11.4V
24V	over 25.2V	24.6V	24.0V	23.4V	under 22.8V
48V	over 50.4V	49.2V	48.0V	46.8V	under 45.6V
60V	over 63.0V	61.5V	60.0V	58.5V	under 57.0V

35. CALLING THE FACTORY FOR ASSISTANCE

When calling OutBack Power for product assistance, please have the following information ready:

- Charge Controller Serial number and software version (the software version can be viewed by pressing the #1 soft key on the STATUS screen and then pressing a second time and holding the soft key down).
- The nominal PV array and battery voltage.
- The PV array operating voltage and battery current and any Status screen operational mode displays, such as *MPPT BULK*, *MPPT FLOAT*, *Absorbing*, or *Floating*.

36. SPECIFICATIONS

Output Current Rating, FLEXmax 80	80 amps continuous @ 40°C ambient
Output Current Rating, FLEXmax 60	60 amps continuous @ 40°C ambient
Default Battery System Voltage	12, 24, 36, 48 or 60VDC (adjustable)
PV open circuit voltage	150VDC Maximum (ETL Rating for UL1741 Standard); operational max = 145VDC temperature corrected VOC
Standby power consumption	Less than 1 watt typical
Recharging regulation methods	Five stage—Bulk, Absorption, Battery Full, Float, and Equalization
Voltage regulation set points	13-80VDC
Temperature compensation	With optional RTS sensor 5 millivolts °C per 2V cell
Voltage step down capability	Down convert from any PV array voltage within PV VOC limits of 145VDC to any battery system voltage. Examples: 72V array to 24V; 60V array to 48V
Digital Display	4 line 20 character per line backlit LCD display
Remote Interface	RJ45 modular connector Cat 5 cable 8 wire
Operating Temperature Range*	-40° to 60°C de-rated above 40°C
Environmental Rating	Indoor type 1
Conduit knockouts	One 1" on the back; one 1" on the left side; two 1" on the bottom
Warranty	Five years parts and labor
Dimensions	FLEXmax 80—16.25"H x 5.75"W x 4"D Boxed—21"H x 10.5"W x 9.75"D FLEXmax 60—13.5"H x 5.75"W x 4"D Boxed—18"H x 11"W x 8"D
Weight	FLEXmax 80—12.20 lbs; Boxed—15.75 lbs FLEXmax 60—11.6 lbs; Boxes—14 lbs
Options	Remote Temperature Sensor (RTS), HUB 4, HUB 10, MATE, MATE2
Menu Languages	English and Spanish

*The Charge Controller automatically limits the current if the temperature rises above the allowable limit.



FIVE YEAR LIMITED WARRANTY INFORMATION

FLEXmax Products

OutBack Power Systems, Inc. ("OutBack") provides a five year (5) limited warranty ("Warranty") against defects in materials and workmanship for its FLEXmax products ("Products") if installed in fixed location applications.

For this Warranty to be valid, the Product purchaser must complete and submit the applicable Product registration card within ninety (90) days of the eligible Product's first retail sale. This Warranty applies to the original OutBack Product purchaser, and is transferable only if the Product remains installed in the original use location. The warranty does not apply to any Product or Product part that has been modified or damaged by the following:

- Installation or Removal;
- Alteration or Disassembly;
- Normal Wear and Tear;
- Accident or Abuse;
- Corrosion;
- Lightning;
- Repair or service provided by an unauthorized repair facility;
- Operation contrary to manufacturer product instructions;
- Fire, Floods or Acts of God;
- Shipping or Transportation;
- Incidental or consequential damage caused by other components of the power system;
- Any product whose serial number has been altered, defaced or removed; or
- Any other event not foreseeable by OutBack.

OutBack's liability for any defective Product, or any Product part, shall be limited to the repair or replacement of the Product, at OutBack's discretion. OutBack does not warrant or guarantee workmanship performed by any person or firm installing its Products. This Warranty does not cover the costs of installation, removal, shipping (except as described below), or reinstallation of Products.

To request warranty service, you must contact OutBack Technical Services at (360) 435-6030 or support@outbackpower.com within the effective warranty period. If warranty service is required, OutBack will issue a Return Material Authorization (RMA) number. A request for an RMA number requires all of the following information:

1. Proof-of-purchase in the form of a copy of the original Product purchase invoice or receipt confirming the Product model number and serial number;
2. Description of the problem; and
3. Shipping address for the repaired or replacement equipment.

After receiving the RMA number, pack the Product(s) authorized for return, along with a copy of the original purchase invoice and warranty certificate, in the original Product shipping container(s) or packaging providing equivalent protection and mark the outside clearly with the RMA number. The sender must prepay all shipping charges, and insure the shipment, or accept the risk of loss or damage during shipment. OutBack is not responsible for shipping damage caused by improperly packaged Products, the repairs this damage might require, or the costs of these repairs. If, upon receipt of the Product, OutBack determines the Product is defective and that the defect is covered under the terms of this Warranty, OutBack will then and only then ship a repaired or replacement Product to the purchaser freight prepaid, non-expedited, using a carrier of OutBack's choice within the continental United States, where applicable

Shipments to other locations will be made freight collect. The warranty period of any repaired or replacement Product is twelve (12) months from the date of shipment from OutBack, or the remainder of the initial warranty term, which ever is greater.

THIS LIMITED WARRANTY IS THE EXCLUSIVE WARRANTY APPLICABLE TO OUTBACK PRODUCTS. OUTBACK EXPRESSLY DISCLAIMS ANY OTHER EXPRESS OR IMPLIED WARRANTIES OF ITS PRODUCTS, INCLUDING BUT NOT LIMITED TO ANY IMPLIED WARRANTIES OF MERCHANTABILITY OR FITNESS FOR A PARTICULAR PURPOSE. OUTBACK ALSO EXPRESSLY LIMITS ITS LIABILITY IN THE EVENT OF A PRODUCT DEFECT TO REPAIR OR REPLACEMENT IN ACCORDANCE WITH THE TERMS OF THIS LIMITED WARRANTY AND EXCLUDES ALL LIABILITY FOR INCIDENTAL OR CONSEQUENTIAL DAMAGES, INCLUDING WITHOUT LIMITATION ANY LIABILITY FOR PRODUCTS NOT BEING AVAILABLE FOR USE OR LOST REVENUES OR PROFITS, EVEN IF IT IS MADE AWARE OF SUCH POTENTIAL DAMAGES. SOME STATES (OR JURISDICTIONS) MAY NOT ALLOW THE EXCLUSION OR LIMITATION OF WARRANTIES OR DAMAGES, SO THE ABOVE EXCLUSIONS OR LIMITATIONS MAY NOT APPLY TO YOU.



FLEXmax™ 60

FLEXmax™ 80

Limited Warranty Registration

Complete this form to request a Limited Warranty, and return it to:

Outback Power Systems Inc.
19009 62nd Ave. NE
Arlington, WA 98223

NOTE: A Limited Warranty Certificate will only be issued if this Registration Card is received by OutBack within 90 days of the date of the first retail sale of the eligible Product. Please submit a copy (not the original) of the Product purchase invoice, which confirms the date and location of purchase, the price paid, and the Product Model and Serial Number.

Five Year Limited FLEXmax Warranty Registration

System Owner

Name: _____ Country: _____
Address: _____ Telephone Number: _____
City, State, Zip Code: _____ E-mail: _____

Product

Product Model Number: _____ Sold by: _____
Product Serial Number: _____ Purchase Date: _____
Optional Extended Warranty* Coverage? (circle one): Yes No

Please circle the three most important factors affecting your purchase decision:

- Price
- Product Reputation
- Product Features
- Reputation of OutBack Power Systems
- Value

System

System Install/Commission Date: _____ Number of FLEXmax Products in System: _____
FLEXmax Charging Source(i.e. Solar): _____ System Array Size: _____
System Array Nominal Voltage: _____ Type of PV Modules: _____
DC Input Wiring Size and Length: _____ System Battery Bank Size (Amp Hours): _____
Type of Batteries: _____

Installer

Installer: _____ Contractor Number: _____
Installer Address: _____ Installer City, State, Zip: _____
Installer E-mail: _____

*Extended Warranty

OutBack Power Systems offers an optional five(5) year extension to the standard five(5) year Limited Warranty in North America for the Charge Controller product. To request a 5-year Limited Warranty extension for a total effective warranty coverage period of ten(10) years; include a check or money order in the amount of \$250USD payable to OutBack Power Systems, Inc. along with your Warranty Registration.

EU DECLARATION OF CONFORMITY

According to ISO / IEC Guide 22 and EN 45014

Product Type: Photovoltaic Charge Controller

Product Model Number: Charge Controller

This product complies with the following EU directives:

Electromagnetic Compatibility 89/336/EEC, "Council Directive of 3 May 1989

On the approximation of the laws of member States relating to Electromagnetic compatibility"

Low Voltage Directive 73/23/EEC, "Council Directive of 19 February 1973 on the harmonization of the laws of Member States relating to electrical equipment for use within certain voltage limits"

The compliance of the above mentioned product with the directives and the following essential requirements is hereby confirmed:

Emissions Immunity Safety

EN 61000-6-3 (2001) EN 61000-6-1 (2001) EN 60335-1 Battery Chargers

EN 60335-2-29 Battery Chargers

All associated technical files are located in the Engineering Department at OutBack Power Systems Inc., Arlington, Washington, USA.

As the manufacturer, we declare under our sole responsibility that the above-mentioned product complies with the above-named directives.



19009 62nd Ave. NE
Arlington, WA. 98223 USA
(360) 435-6030

OWNER'S SYSTEM INFORMATION

Date of Purchase: _____

Vendor: _____

Date of Installation: _____

Installer: _____

Installer Contact Information: _____

Charge Controller Serial Number: _____

Battery Voltage: _____

PV Voltage: _____

PV Module Type and Manufacturer: _____

Array Wattage: _____

NOTES: _____



Corporate Office
19009 62nd Avenue NE
Arlington, WA USA
Phone: (+1) 360-435-6030

www.outbackpower.com

European Sales Office
C/ Castelló, 17
08830 - Sant Boi de Llobregat
BARCELONA, España
Phone: +34.93.654.9568

900-0009-01-00 REV A